

Ermetika[®]

DESIGN PASSAGES

BROCHURE
PRODOTTI
— 2024

Ermetika[®]
DESIGN PASSAGES

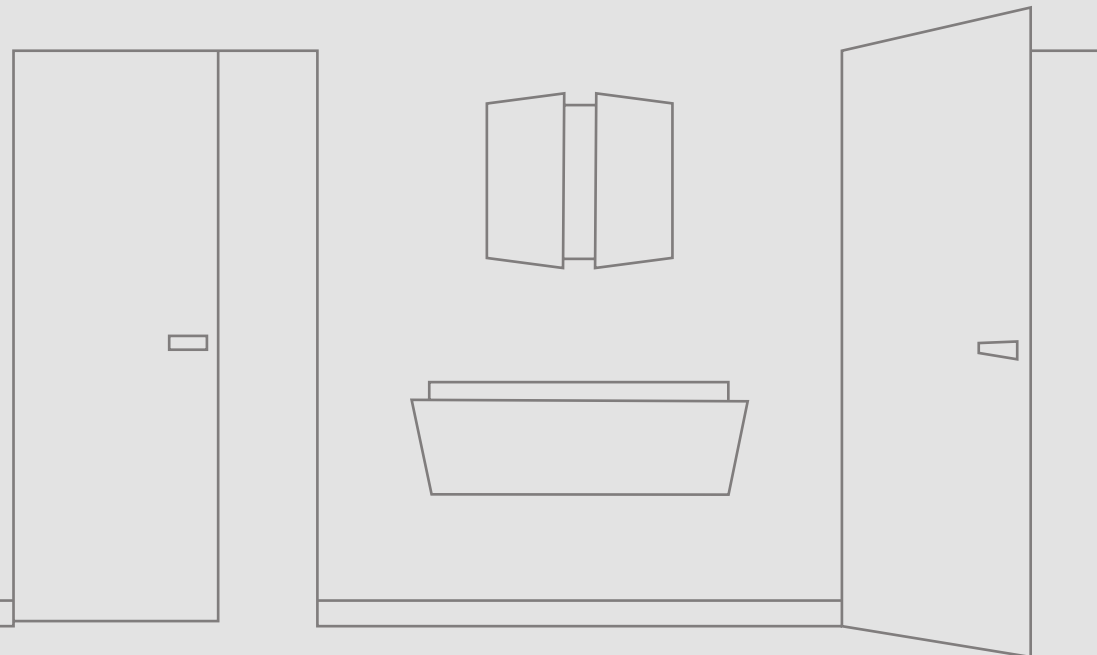

Il mondo Ermetika

Da 35 anni realizziamo soluzioni

in grado di semplificare ed allo stesso tempo arricchire la vita dei nostri clienti impegnandoci ogni giorno come fosse il primo.

Bussa alle porte della qualità ed entra nel nostro mondo!

*For 35 years, we have been producing **opening systems** that simplify and enrich the lives of our customers, by committing to our work every day as if it was the first.*

Knock on the doors of quality and enter our world!

ERMETIKA crea passaggi per l'architettura del vivere. Soluzioni intelligenti e di design che rendono anche i gesti più semplici delle vere e proprie esperienze per guardare al futuro con occhi sempre nuovi.

ERMETIKA creates passages for the architecture of everyday life. Smart design solutions turn even the simplest gestures into real experiences so that we can always see the future with new eyes.

Tecnologia & Innovazione

TECHNOLOGY AND INNOVATION

In 35 anni di attività uno dei principali motori a guidare l'evoluzione di Ermetika è stata la voglia di non accontentarsi mai. Ricerca applicata e innovazione hanno portato all'ideazione di un impianto produttivo completamente progettato in ottica di **industria 4.0**.

MES - PROGRAMMA, PIANIFICA E MONITORA IN TEMPO REALE LA PRODUZIONE ASSICURANDO UN CONTROLLO QUALITÀ MINUZIOSO.

WMS - CONTROLLA GIACENZE MAGAZZINO, OTTIMIZZA GLI SPAZI E TRACCIA IL PERCORSO DI OGNI SINGOLO PRODOTTO O COMPONENTE.

*In 35 years of work, one of the main driving forces behind Ermetika's evolution has been the desire to never be satisfied. As a result, applied research and innovation have created a production plant completely designed with the **Industry 4.0 vision**.*

MES - IT SCHEDULES, PLANS AND MONITORS PRODUCTION IN REAL-TIME, ENSURING METICULOUS QUALITY CONTROL.

WMS - IT CONTROLS WAREHOUSE STOCKS, OPTIMISES SPACES AND TRACKS THE PATH OF EACH INDIVIDUAL PRODUCT OR COMPONENT.

I vantaggi di Ermetika

ERMETIKA'S KEY STRENGTHS



TECNOLOGIA INVISIBILE
INVISIBLE TECHNOLOGY

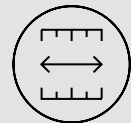

PROGETTO SU MISURA
CUSTOM PROJECT



SCORRIMENTO SILENZIOSO
SMOOTH SLIDING



ZINCATURA A CALDO
HOT DIP GALVANIZING



ARTIGIANLITÀ INDUSTRIALE
INDUSTRIAL CRAFTSMANSHIP

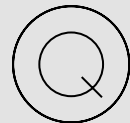

QUALITÀ TOTALE
TOTAL QUALITY



ECO SOSTENIBILITÀ
ECO SUSTAINABILITY



DESIGN E AFFIDABILITÀ
DESIGN AND RELIABILITY



INNOVAZIONE CONTINUA
CONSTANT INNOVATION



SERVIZIO EFFICIENTE
EFFICIENT SERVICE



PRESENZA INTERNAZIONALE
INTERNATIONAL PRESENCE



PASSIONE PER IL MESTIERE
PASSION FOR WORK

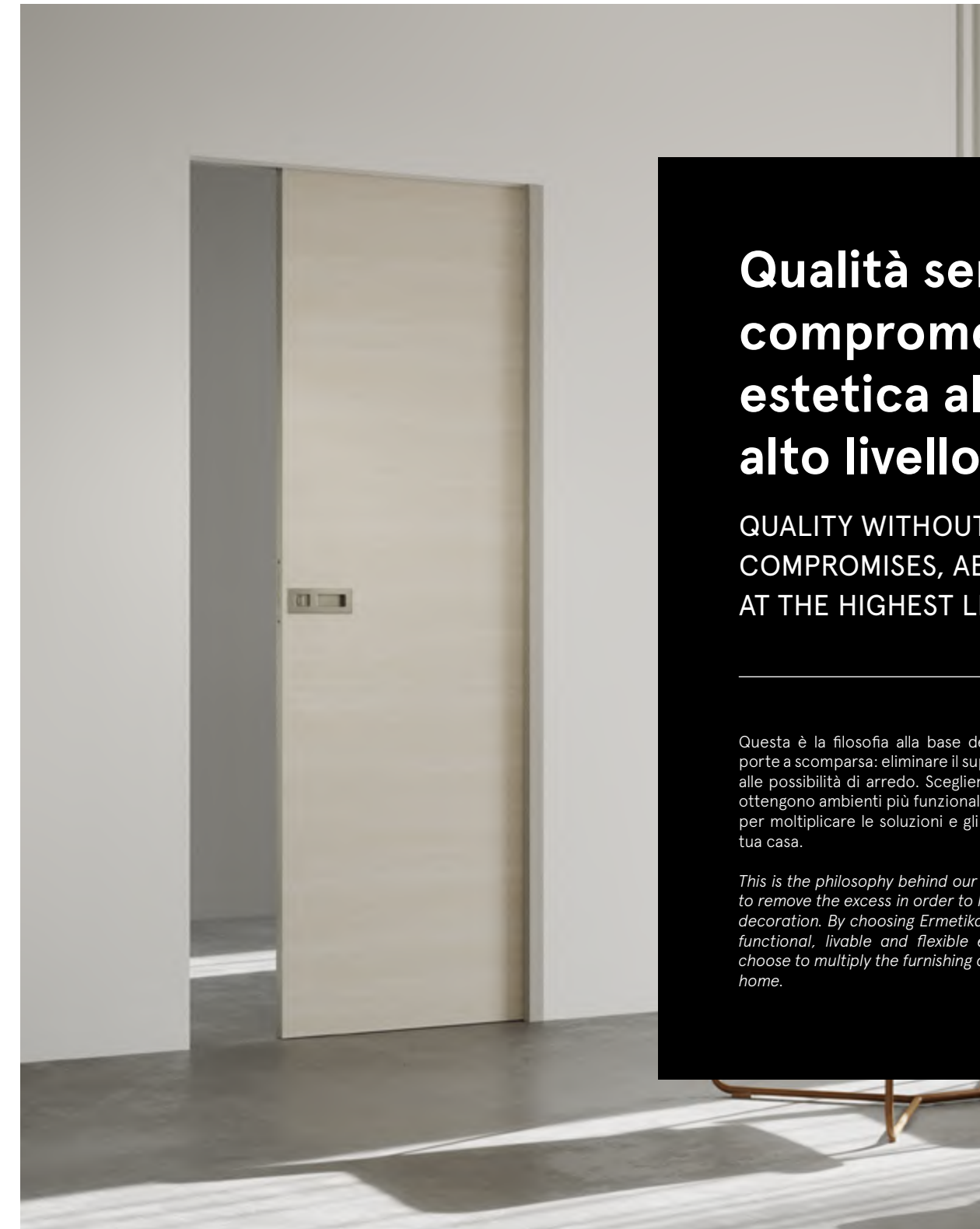

Qualità senza compromessi, estetica al più alto livello.

QUALITY WITHOUT COMPROMISES, AESTHETICS AT THE HIGHEST LEVEL.

Questa è la filosofia alla base della nostra produzione di porte a scomparsa: eliminare il superfluo per lasciare spazio alle possibilità di arredo. Scegliendo i prodotti Ermetika si ottengono ambienti più funzionali, più vivibili e più flessibili; per moltiplicare le soluzioni e gli stili di arredamento della tua casa.

This is the philosophy behind our pocket doors production: to remove the excess in order to leave room for any kind of decoration. By choosing Ermetika's products you get more functional, livable and flexible environments; finally, you choose to multiply the furnishing options and styles for your home.

Porta scorrevole Filo Muro
Flush sliding pocket door system

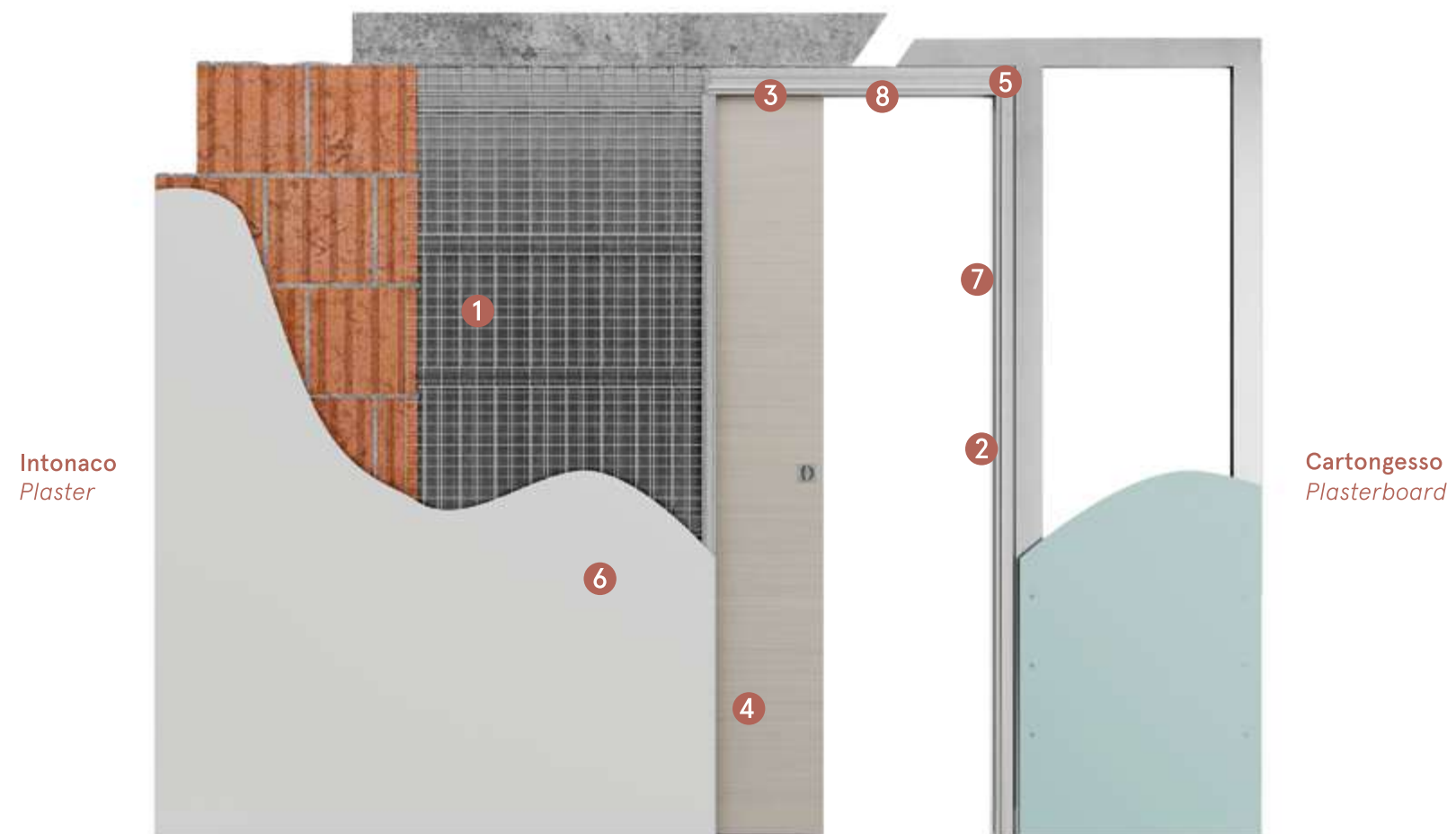

Porta scorrevole con stipiti
Classic sliding pocket door system

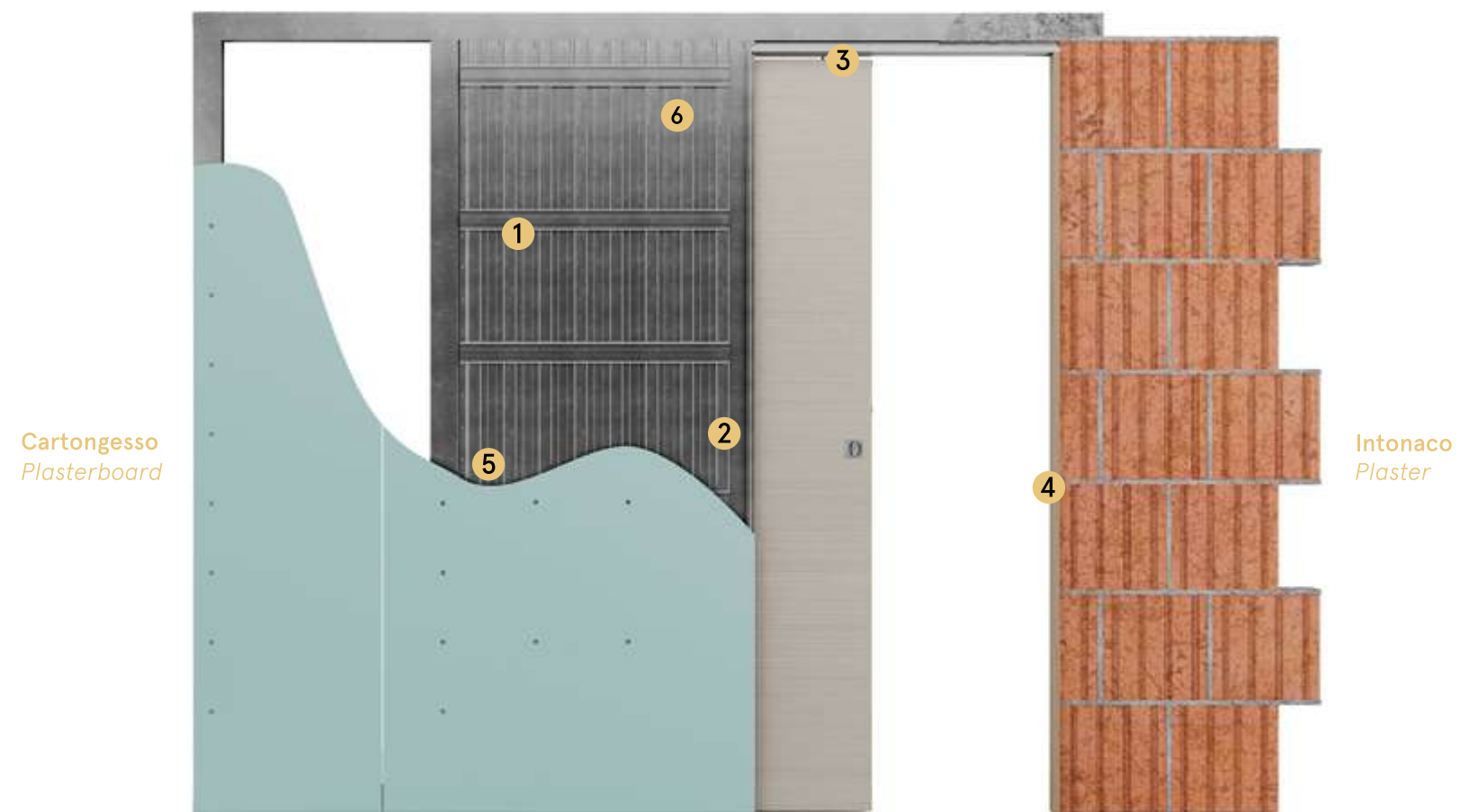

- 1 **ROBUSTEZZA ASSOLUTA**
STRUCTURAL STRENGTH
- 2 **PROFILI IN ALLUMINIO**
ALUMINIUM PROFILES
- 3 **PROFILO SALVADESIGN**
DESIGN-SAVING TOP PROFILE
- 4 **FINITURE ANTA PERSONALIZZABILI**
CUSTOMIZABLE DOOR FINISHES
- 5 **ALLINEAMENTO PRECISO ANGOLI**
PRECISE ANGLE ALIGNMENT
- 6 **PERFETTA ADESIONE**
PERFECT ADHERENCE
- 7 **MONTANTE IN LEGNO**
WOODEN DOOR JAMB
- 8 **BINARIO ESTRAIBILE**
EXTRACTIBLE RAIL

- 1 **INDEFORMABILITÀ E RESISTENZA**
STRESS RESISTANT AND SHAPE-RETAINING
- 2 **RIGIDITÀ STRUTTURALE**
STRUCTURAL STRENGTH
- 3 **FLUIDITÀ DI SCORRIMENTO**
SILENT AND FLUID SLIDING
- 4 **MONTANTE DI BATTUTA IN LEGNO**
WOODEN DOOR JAMB
- 5 **PERFETTA ADESIONE**
PERFECT ADHERENCE
- 6 **MONTAGGIO SEMPLICE**
EASY SET-UP

Porta battente Filo Muro
Flush hinged door system

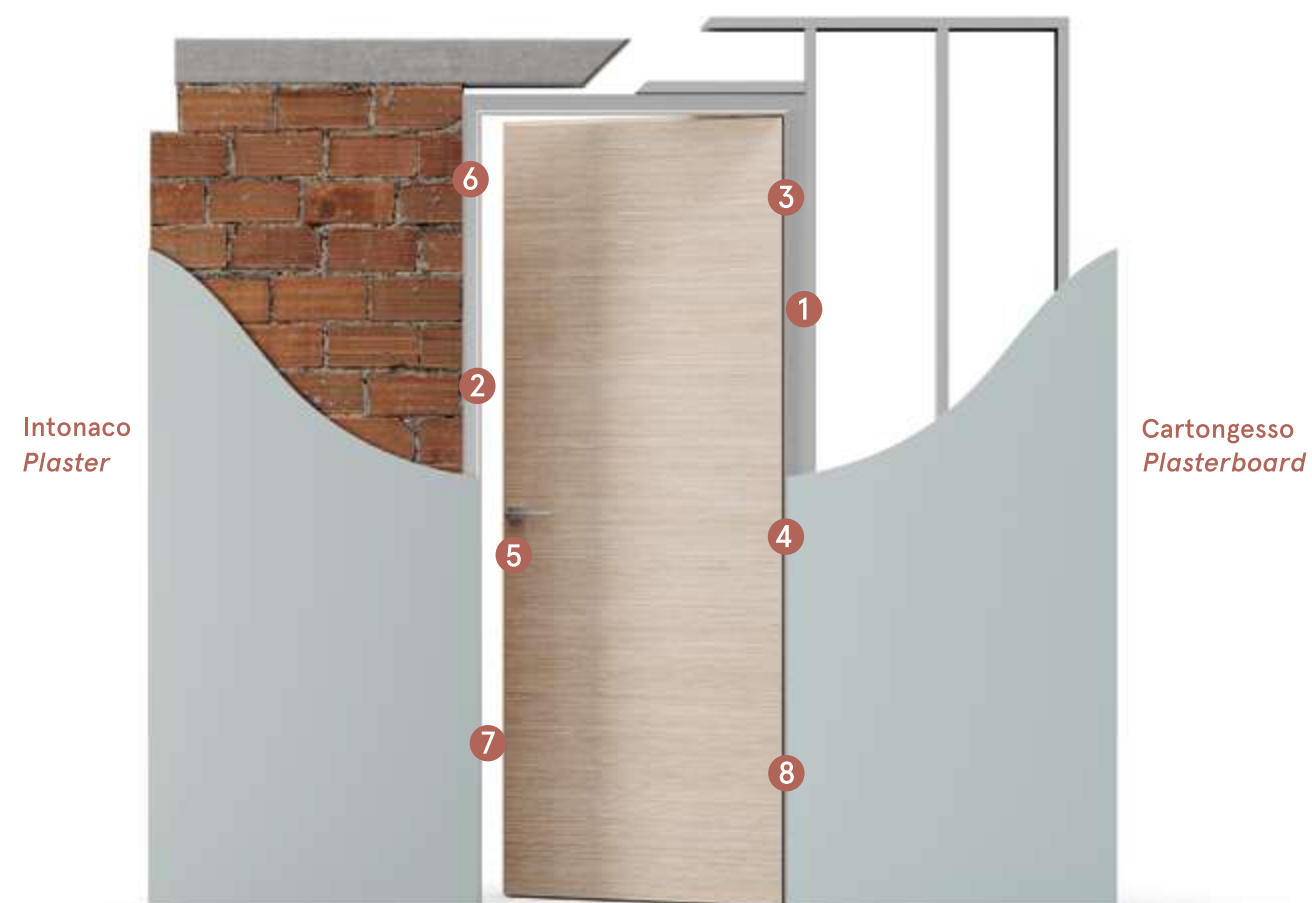

- 1 **ROBUSTEZZA ASSOLUTA**
STRUCTURAL STRENGTH
- 2 **GUARNIZIONE DI BATTUTA**
FOAM GASKET
- 3 **INSERTI FILETTATI**
THREADED INSERTS
- 4 **CERNIERE PORTATA 40-80KG**
HINGES WITH 40-80 KG CAPACITY
- 5 **SERRATURA MAGNETICA**
MAGNETIC LOCK
- 6 **PROFILO SPESSORE INTEGRALE**
SAME WALL THICKNESS
- 7 **DISTANZIALI IN LEGNO**
WOOD SPACERS
- 8 **CERNIERE REGOLABILI SU 3 ASSI**
THREE ADJUSTABLE HINGES

Porta scorrevole con stipiti in kit
Classic sliding pocket door kit

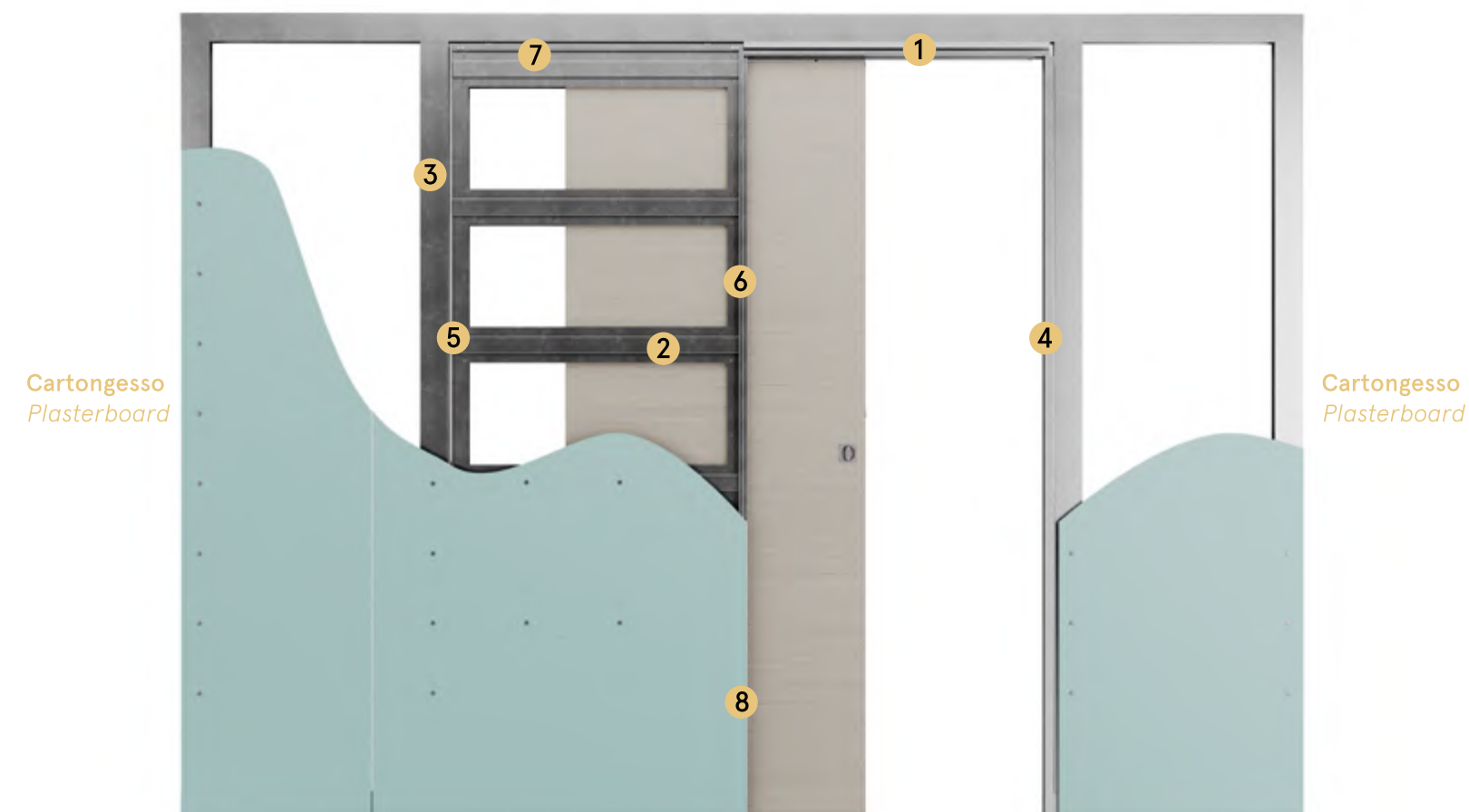

- 1 **BINARIO ESTRAIBILE**
EXTRACTIBLE RAIL
- 2 **RIGIDITÀ STRUTTURALE**
STRUCTURAL STRENGTH
- 3 **TENUTA VERTICALE ASSOLUTA**
ABSOLUTE FIRMNESS
- 4 **ADATTABILITÀ ALLA PARETE**
ADJUSTABLE THICKNESS
- 5 **PERFETTA ADESIONE**
PERFECT ADHERENCE
- 6 **FLESSIBILITÀ LOGISTICA**
LOGISTIC FLEXIBILITY
- 7 **MONTAGGIO SEMPLICE**
EASY SET-UP
- 8 **RISULTATO ESTETICO PERFETTO**
STUNNING AESTHETICAL RESULT

Design per ogni ambiente

DESIGN LINES FOR EVERY ENVIRONMENT

Nuovo Scenario

NEW SCENARIO

Ermetika suggerisce da sempre soluzioni dalla massima praticità per elevare l'esperienza di vita, concentrandosi su armonia architettonica e vivibilità personale. Una filosofia orientata al design che abbraccia la qualità e la combinazione di materiali pregiati, costituendo la base per la massima resa estetica delle soluzioni firmate Ermetika.

Ermetika has always suggested solutions of the highest practicality to elevate the experience of living spaces, focusing on architectural harmony and personal livability. Furthermore, its design-oriented philosophy embraces quality and the combination of fine materials, laying the foundation for the maximum aesthetic performance of Ermetika's solutions.

LINEA CLASSIC



LINEA ABSOLUTE



LINEA PORTE



DOMUS SF
K1 - ArtStudio

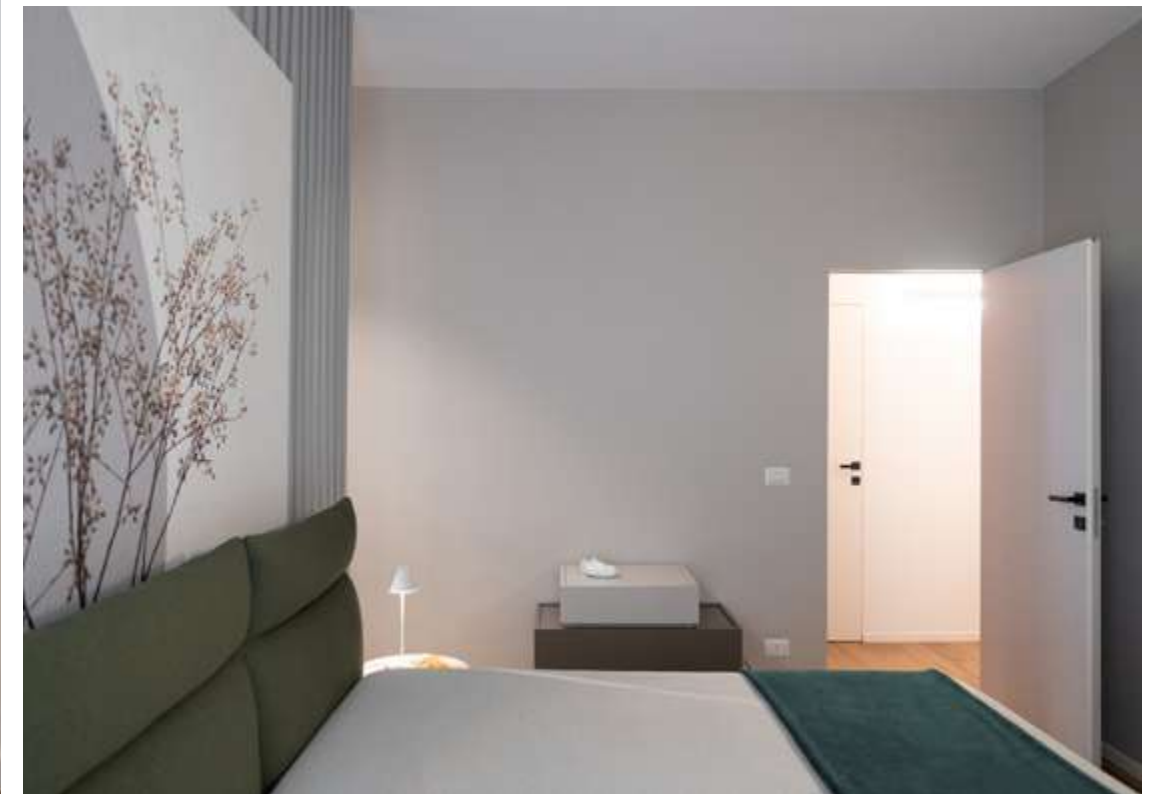



DOMUS SP



DOMUS LR
K1 Artstudio



DOMUS LR
K1 Artstudio

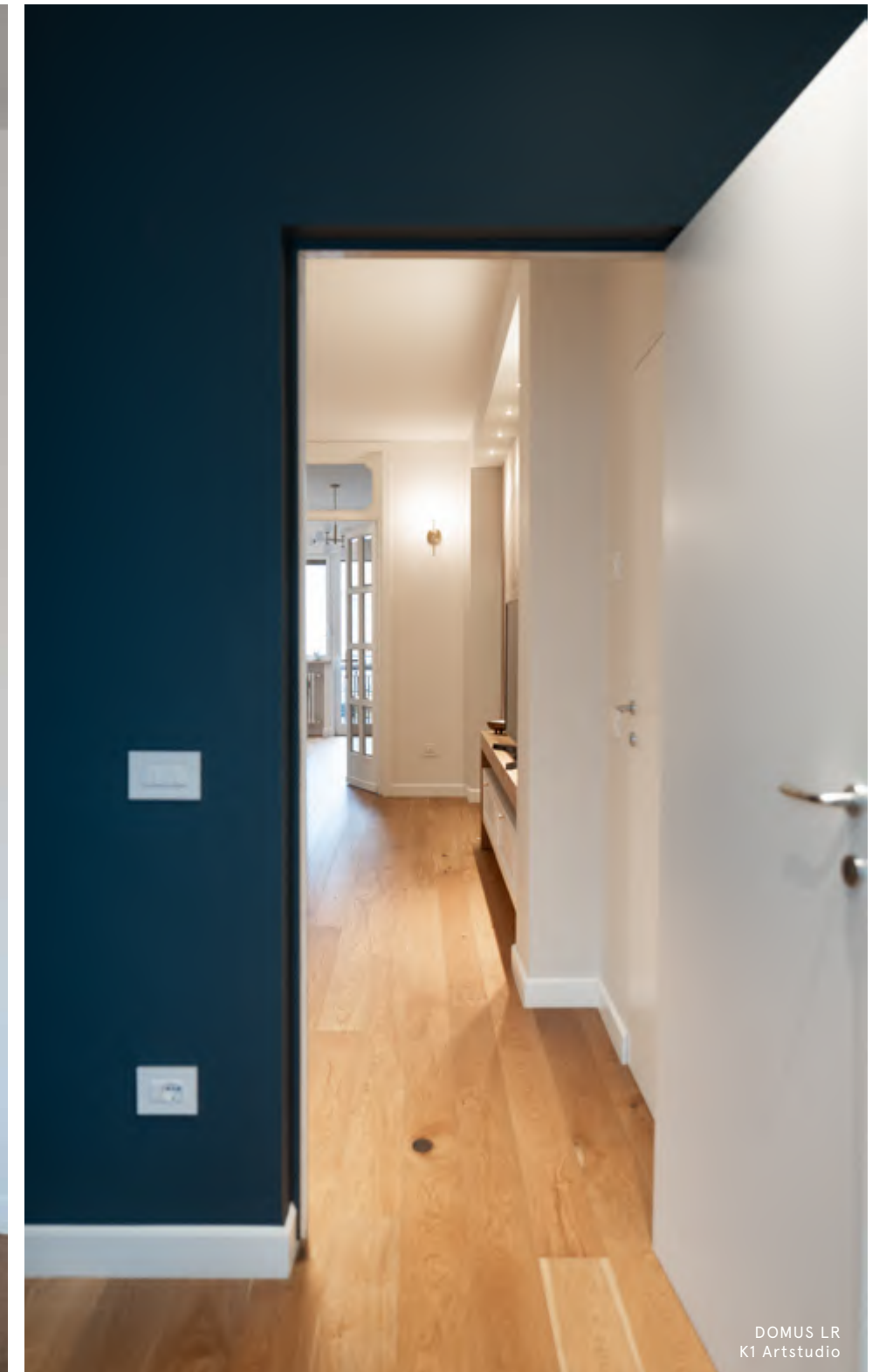

DOMUS LR
K1 Artstudio



DOMUS SP



DOMUS SP



CASA DANISI
Roberto Ruta Architetto



CASA DANISI
Roberto Ruta Architetto

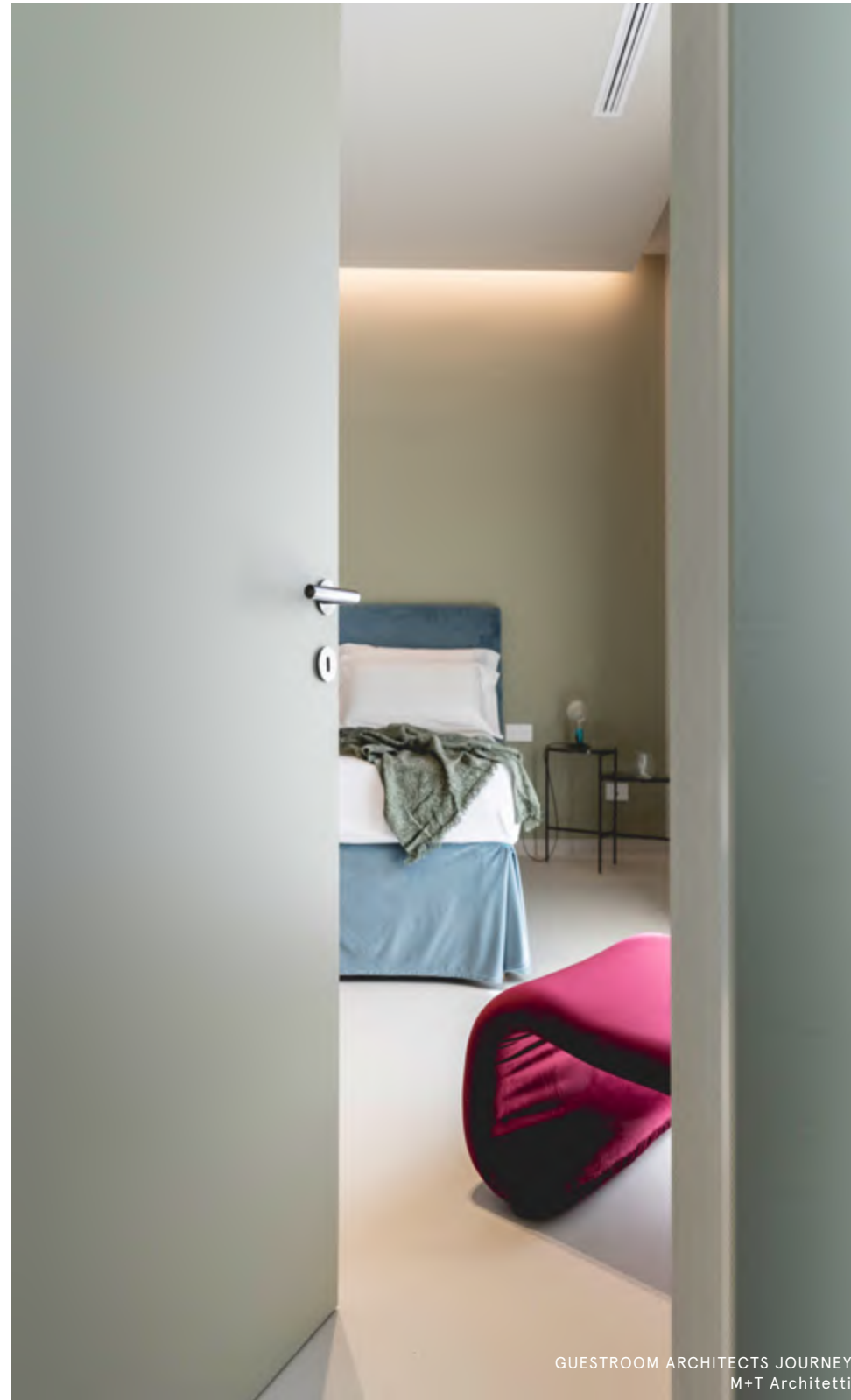

GUESTROOM ARCHITECTS JOURNEY
M+T Architetti

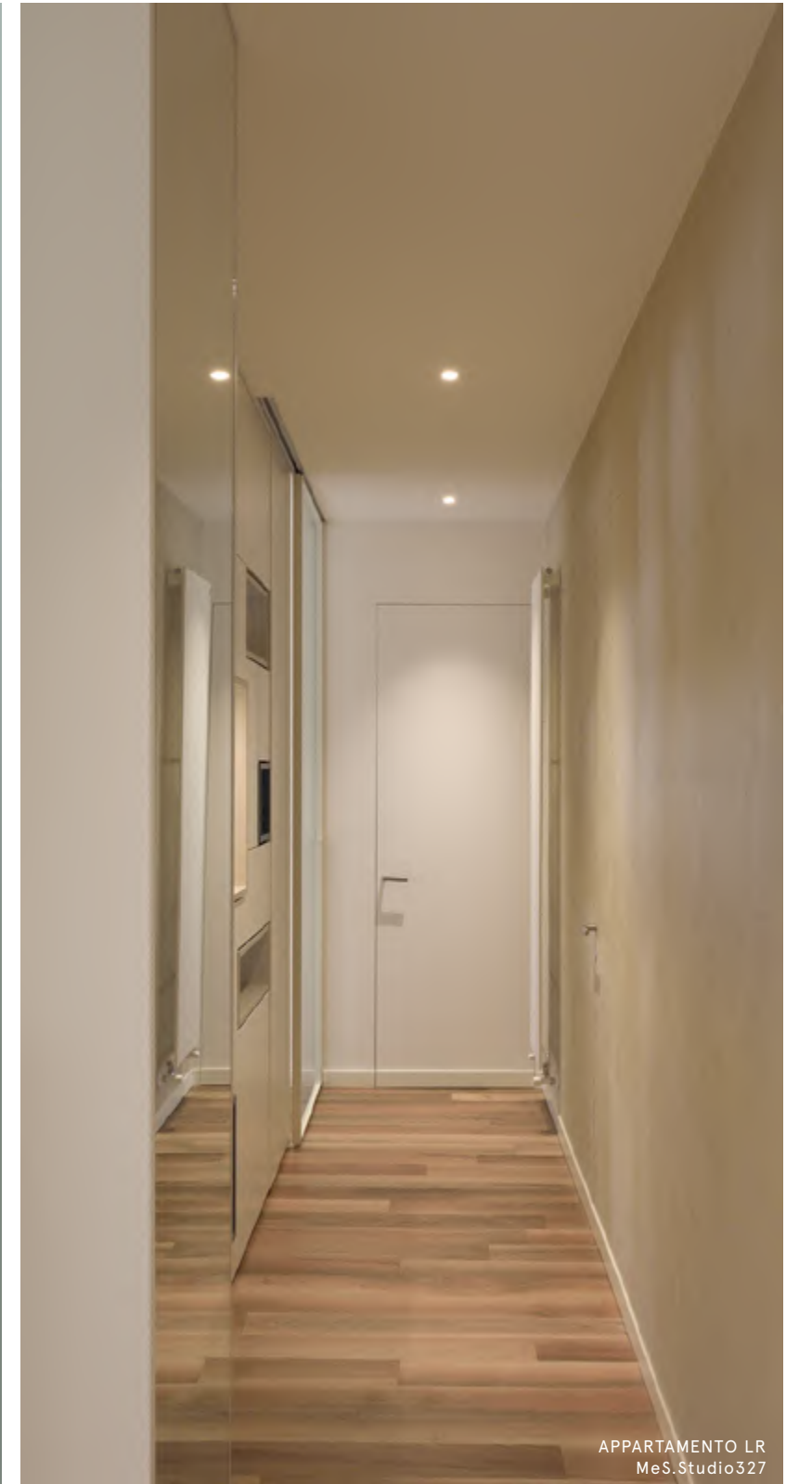

APPARTAMENTO LR
MeS.Studio327

MDY-MEDICAL
Zalman Perry





FALAISE
Bcoz Architecture d'intérieur



FALAISE
Bcoz Architecture d'intérieur



DOMUS SP

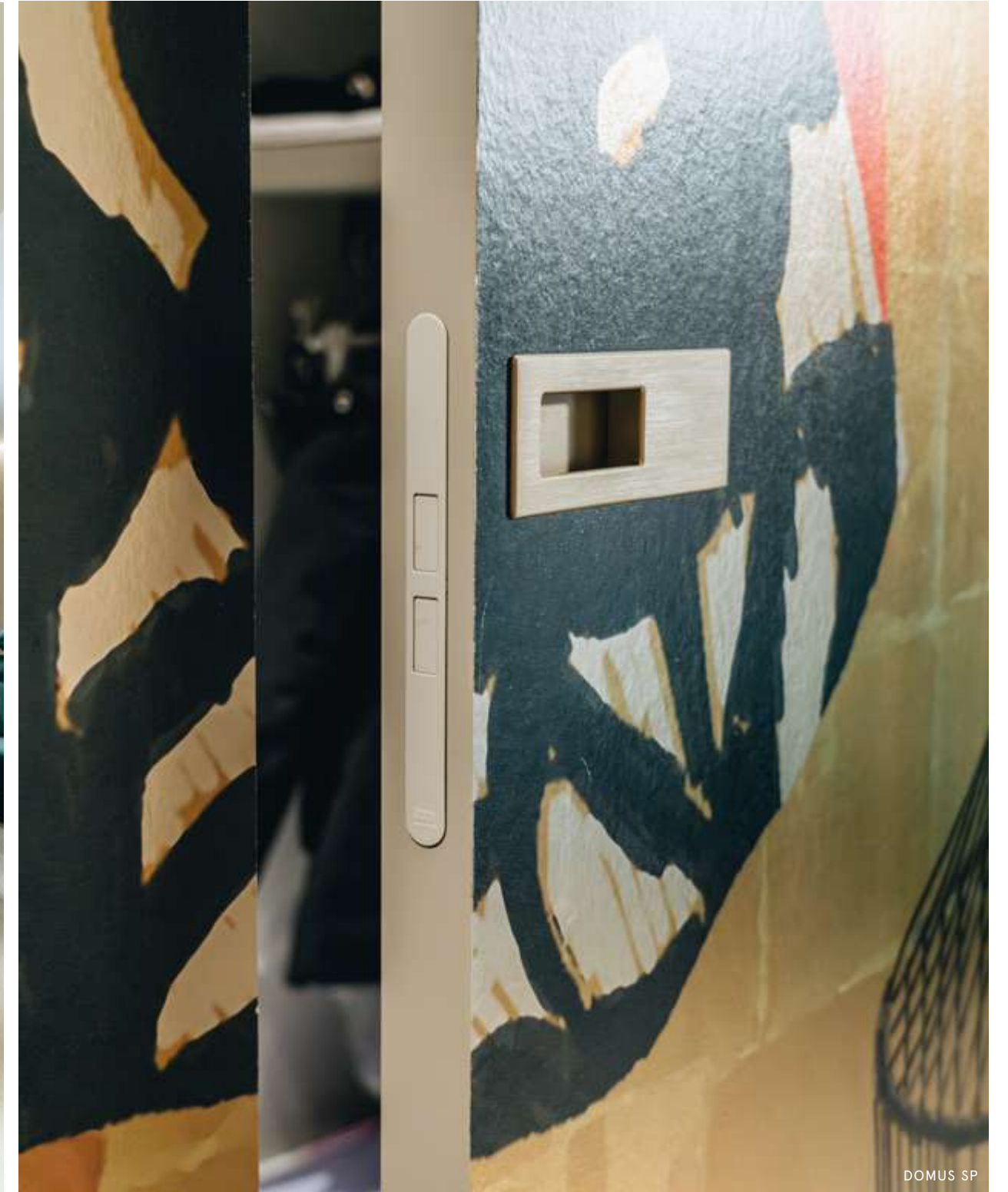

DOMUS SP

01

Ermetika[®]
DESIGN PASSAGES

ABSOLUTE

LINEA FILO MURO

FLUSH TO WALL

La soluzione senza confini per i vari ambienti della casa. Con la linea ABSOLUTE filo muro si sceglie un'estetica minimale dalla massima resa, con zero sporgenze architettoniche per spazi abitativi essenziali ed eleganti.

The most versatile solution for any rooms of the house. With the flush-to-wall ABSOLUTE line, you can choose a minimalist design with the best results and zero architectural complexity, for essential and elegant living solutions.



ABSOLUTE swing

PARETE / Wall



Cartongesso
Plasterboard



Intonaco
Plaster

RIVESTIMENTO / Finish



Laccata
Lacquering



Carta da Parati
Wallpaper



Tinteggiatura
Painting

MISURE / Dimensions



LARGHEZZA/Width
da 600 a 1000 mm
From 600 to 1000 mm



ALTEZZA/Height
da 1500 a 2700 mm
from 1500 to 2700 mm

Absolute Swing è il modello a battente privo di stipiti e coprifili che risponde alle necessità delle nuove tendenze, costantemente alla ricerca di sistemi innovativi in grado di coniugare funzionalità e design. Il mix unico di design sofisticato, tecnologia innovativa e attenzione al dettaglio fa di questo prodotto una scelta **incomparabile per coloro che cercano qualità e stile di alto livello.**

*Absolute Swing is the hinged model without jambs and architraves that responds to the needs of new trends, constantly looking for innovative systems capable of combining functionality and design. The unique mix of sophisticated design, advanced technology and attention to detail makes this product **an incomparable choice for those seeking high-level quality and style.***



Absolute Swing





xREVERx[®]

PORTA FILOMURO REVERSIBILE

PARETE / Wall



Cartongesso
Plasterboard



Intonaco
Plaster

RIVESTIMENTO / Finish



Laccata
Lacquering



Carta da Parati
Wallpaper



Tinteggiatura
Painting

MISURE / Dimensions



LARGHEZZA/Width
da 600 a 900 mm
From 600 to 900 mm



ALTEZZA/Height
2100 mm

xREVERx è la porta filo muro battente reversibile che coniuga versatilità ed estetica in un'unica efficace soluzione. Composto da telaio e porta, il sistema reversibile filo muro permette con pochi semplici passaggi di personalizzare l'intera struttura in base alle proprie esigenze abitative. **Consente di invertire con semplicità i versi di apertura** (spingere o tirare) e passare da un'apertura a destra ad una a sinistra semplicemente ruotando il verso del telaio.

*xREVERx is the flush reversible hinged door system that blends versatility and outstanding aesthetics in one solution. Composed of frame and door, the reversible flush with the wall system allows a full customisation of the frame according to construction needs. **Direction of opening can be inverted** (push or pull) and switched from a left to a right opening by simply rotating the frame.*

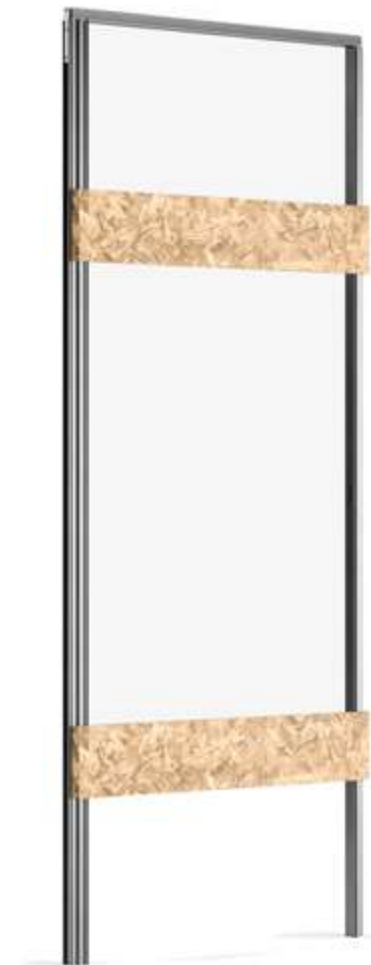



xREVERx







ABSOLUTE evo



PARETE / Wall

-  **Cartongesso**
Plasterboard
-  **Intonaco**
Plaster

RIVESTIMENTO / Finish

-  **Laccata**
Lacquering
-  **Carta da Parati**
Wallpaper
-  **Tinteggiatura**
Painting

MISURE / Dimensions

-  **LARGHEZZA/Width**
da 600 a 1200 mm
From 600 to 1200 mm
-  **ALTEZZA/Height**
da 1000 a 2700 mm
from 1000 to 2700 mm

Absolute Evo è un sistema di porta scorrevole filo muro privo di finiture esterne come stipiti e coprifili che **permette all'anta di fondersi completamente con la parete.** Disponibile sia per intonaco che per cartongesso, con la sua struttura solida e la finitura impeccabile, questo sistema cattura l'attenzione sin dal primo sguardo. Le linee pulite e moderne si sposano armoniosamente con qualsiasi tipo di arredamento, sia esso tradizionale o contemporaneo.

*Absolute Evo is a flush-to-wall sliding door system without external finishes which **lets the door panel seamlessly blend into the wall.** Available for both plaster and plasterboard, its sturdy structure and impeccable finish make Absolute Evo stand out at first glance. The clean and modern lines harmonize perfectly with any style of decor, be it traditional or contemporary.*

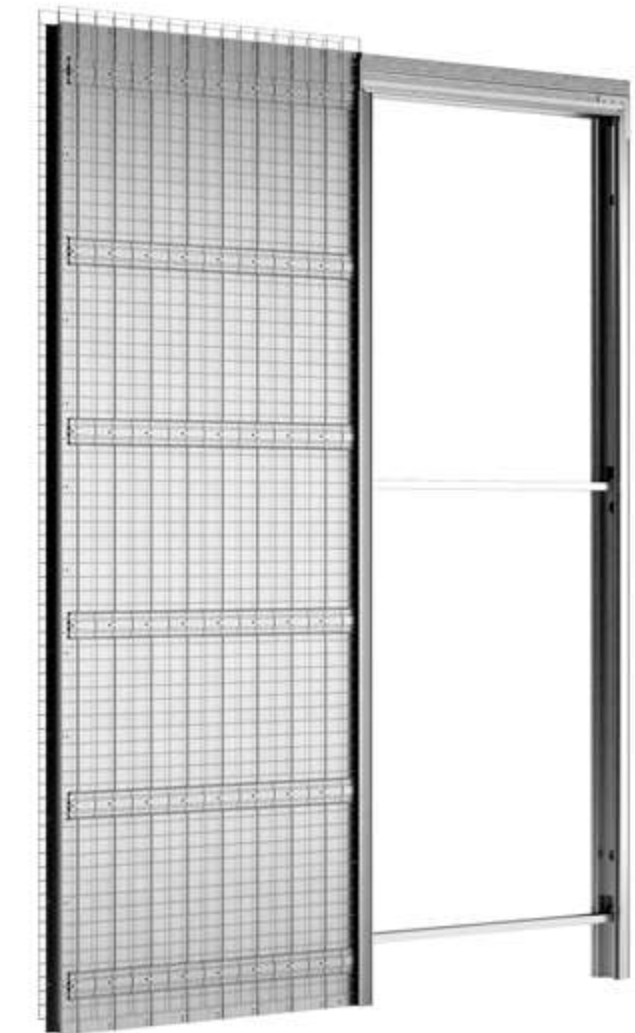

Absolute Evo



ABSOLUTE rush



Il battiscopa minimale per scelte di design che arrivano in ogni angolo. **Absolute Rush** di Ermetika, si inserisce totalmente nella parete che lo ospita: zero sporgenze ed un effetto wow garantito.

*The minimalist skirting board for design choices that reach any corner. **Absolute Rush** by Ermetika fits completely into the wall that houses it: zero protrusions and a guaranteed wow effect.*





01. ABSOLUTE ENERGY

Absolute Energy è la porta scorrevole filo muro predisposta per l'installazione di punti luce, termostati e prese elettriche sulla parete che lo ospita.

Absolute Energy is the flush sliding pocket door system fit for hosting electrical wiring when sockets or switches are needed on the cavity wall.



02. ABSOLUTE EVOKIT

Absolute EvoKit è la versione **filo muro scorrevole in kit**, non assemblata. Disponibile solo per cartongesso, è ideale per progetti che presentano limiti nel trasporto.

*Absolute EvoKit is the **non assembled version** of the flush sliding system. Only available for plasterboard walls, it suits any project which may have delivery constraints.*



05. ABSOLUTE EVO MOTORISED

La principale caratteristica della porta Absolute Evo Motorised è il suo **sistema motorizzato**, che consente un'apertura e una chiusura automatica senza sforzo.

*The key feature of the Absolute Evo Motorised door is its **motorised system**, which provides effortless automatic opening and closing.*



06. ABSOLUTE SWING TUTTA ALTEZZA

Absolute Swing Tutta Altezza è un telaio per porta a battente che **percorre tutta la lunghezza dal pavimento al soffitto**. Il modello, composto solo dai montanti laterali, offre un impatto scenografico che trasforma gli ambienti in spazi ampi ed eleganti.

*Absolute Swing Full Height is a hinged door frame that **runs all the length from the floor to the ceiling**. This model, only made by lateral jambs, offers a unique aesthetic that turns any room into a broad and elegant space.*



03. ABSOLUTE SMART

Gli sportellini filo muro Absolute Smart sono progettati per **celare e allo stesso tempo rendere facilmente accessibili** piccoli vani per impianti elettrici, ripostigli, credenze etc. Disponibili in diverse configurazioni, si adattano a ogni esigenza.

*Absolute Smart hidden storage panels are **designed to conceal - all the while providing easy access to** - electrical systems, storage spaces, cabinets etc. Available with various configurations, they suit any request.*



04. ABSOLUTE EVO TUTTA ALTEZZA

Absolute Evo Tutta Altezza è un sistema scorrevole senza stipiti o coprifili che prevede l'integrazione del **binario superiore direttamente a soffitto**. Questa tecnologia dona maggiore slancio alla porta e rende otticamente più grande la parete, creando un forte impatto visivo.

*Absolute Evo Full Height is a flush sliding system with the **upper rail directly installed in the ceiling**. This technology makes both the door visually taller and the wall bigger, producing an impressive effect.*



07. ABSOLUTE SWING TRAPEZOIDALE

Absolute Swing Trapezoidale è capace di coniugare i tratti puliti della linea filo muro ad un uso specifico. **Ideale per spazi con particolari esigenze** come, per esempio, mansarde o sottoscala, assolve la sua funzione con estrema eleganza.

*Absolute Swing Trapezoidal is able to combine the clean structure of the flush line to a specific use. **Ideale for spaces with technical requirements** such as attics and under-stair closets, it fulfills its function with extreme elegance.*



08. ABSOLUTE SWING ANTA DOPPIA

Absolute Swing a doppia anta presenta porte a battente che si integrano perfettamente nel muro, consentendo l'utilizzo di **due ante con apertura indipendente**. Il modello è adatto per congiungere grandi spazi o per sfruttare le rientranze nelle pareti con una cabina armadio.

*Absolute Swing double door has two hinged panels that perfectly blend with the wall, allowing the **independent opening of each door**. This model is fit for joining big rooms or to exploit a recess in the wall with a walk-in closet.*

02

Ermetika[®]
DESIGN PASSAGES

CLASSIC

CON STIPITI E COPRIFILI

WITH JAMBS AND ARCHITRAVES

Massimo design nel minor spazio possibile. Una linea moderna, realizzata attraverso la tecnologia più avanzata per diventare portavoce di comfort e praticità. Con la linea CLASSIC, guadagnare centimetri importanti nello spazio disponibile non è mai stato così facile.

A modern line created using the most advanced technology to represent comfort and practicality at its best. With the CLASSIC product range, gaining important centimetres in the available space has never been easier.



LINEA CLASSIC EVOLUTION

PARETE / Wall



Cartongesso
Plasterboard



Intonaco
Plaster

RIVESTIMENTO / Cladding



Laccata
Lacquering



Carta da Parati
Wallpaper



Tinteggiatura
Painting

MISURE / Dimensions



LARGHEZZA/Width
da 600 a 1500 mm
from 600 to 1500 mm



ALTEZZA/Height
da 1000 a 2700 mm
from 1000 to 2700 mm

Questo modello con stipiti e coprifili si impone come la scelta prediletta per chi non vuole scendere a compromessi tra bellezza e praticità. Il suo design scorrevole permette di **ottimizzare l'abitabilità e di godere al meglio di ogni spazio.**

*This model with jambs and architraves stands out as the first choice for those who do not want to compromise between beauty and comfort without compromise. Its sliding design allows you to **optimize livability and enjoy every space to its full potential.***



EVOLUTION

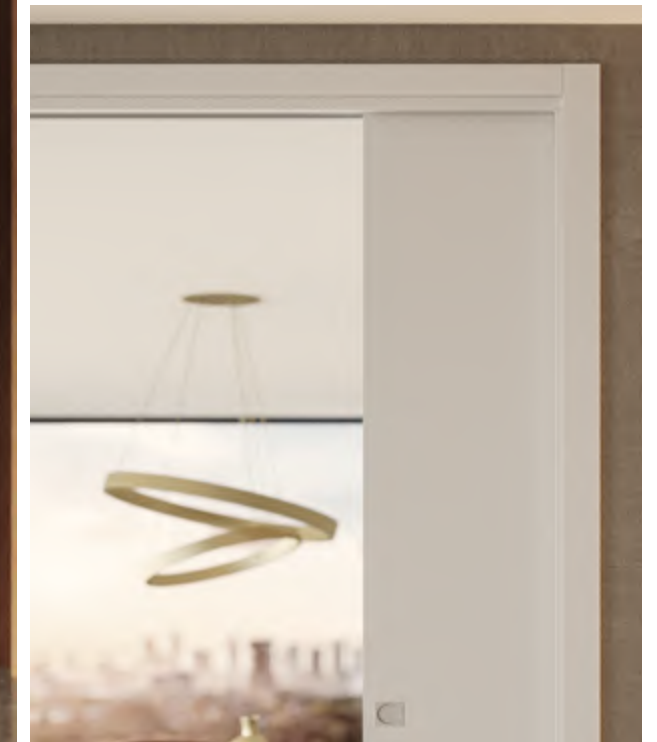



LINEA CLASSIC EVOKIT

EvoKit è la versione classica non assemblata del contro telaio scorrevole con stipiti e coprifili: disponibile in un pratico kit, **facile e rapido da installare**, è in grado di risolvere ogni problema legato ad ambienti ridotti o con limiti di trasporto, così da poterli sfruttare al massimo.

*EvoKit is the non-assembled version of the classic sliding pocket door system: available in a convenient kit that is **easy and quick to install**, it is designed to solve any issue related to small environments or multi-storey buildings with transport constraints, allowing for maximum space utilization.*

PARETE / Wall



Cartongesso
Plasterboard

RIVESTIMENTO / Cladding



Laccata
Lacquering



Carta da Parati
Wallpaper



Tinteggiatura
Painting

MISURE / Dimensions



LARGHEZZA/Width
da 600 a 1200 mm
from 600 to 1200 mm



ALTEZZA/Height
da 1000 a 2700 mm
from 1000 to 2700 mm



EVOKIT



Arkimede



Arkimede è la porta curva scorrevole con stipiti e coprifili brevettata dall'azienda stessa nel 1996. È il modello ideale per chi cerca un prodotto innovativo, ma dall'animo retrò, che esce fuori dalle convenzioni delle linee rette.

Arkimede is the curved sliding door with jambs and architraves patented by the company itself in 1996. It is the ideal model for those seeking an innovative product, with a retro soul, which does not follow the conventional straight lines.





01. STAFFETTA

Grazie ai suoi **pannelli telescopici**, il modello scorrevole Staffetta crea un ampio varco di passaggio, fa circolare al meglio la luce naturale tra gli ambienti e concede massima libertà di movimento.

*Thanks to its **telescopic panels**, the Staffetta sliding pocket door system creates a wide opening passage, lets more natural light in the rooms and allows greater freedom of movement.*



02. LUMINOX

Luminox è un modello intelligente che prevede una canalina all'interno del controtelaio, in grado di ospitare cavi elettrici, telefonici e altri tipi di cavi, consentendo così l'**installazione di cassette elettriche sulla parete**.

*Luminox is an intelligent model with a conduit located on the pocket door frame that can accommodate electrical cables, telephone wires, etc., thus enabling the **installation of light fixtures on the wall**.*



05. UNICO EVO

Unico Evo ospita **due ante parallele che scorrono in senso inverso** in un unico e pratico controtelaio, rendendo semplice e lineare l'accesso ad ambienti adiacenti.

*Unico Evo accommodates **two parallel panels that slide in opposite directions** within a single and practical cavity, providing easy and seamless access to adjacent areas.*



06. EVOLUTION MOTORISED

Evolution Motorised è il sistema classico scorrevole dotato di un dispositivo e di accessori che consentono alla porta di **aprirsi e chiudersi in modo completamente automatico**, grazie al rilevamento della presenza o del movimento degli abitanti.

*Evolution Motorised is the classic pocket door system equipped with a device and accessories that allow the door to **open and close automatically**, by detecting the presence or movement of occupants.*



03. EVOKIT STAFFETTA

Evokit Staffetta è l'**alternativa in kit al modello scorrevole telescopico**. È il risultato di una progettazione il cui scopo è rendere il sistema semplice ed efficace, ma allo stesso tempo mantenere il suo lato raffinato ed elegante, in grado di risolvere qualsiasi ostacolo legato a trasporti più complessi.

*EvoKit Staffetta is the **non-assembled alternative to the telescopic pocket door system**. It is the result of a design aimed at making the product simple and effective, while maintaining its refined and elegant aspect. It can overcome any obstacles related to more complex transportation requirements.*



04. BIN AIR

BinAir è il binario per porta scorrevole esterno muro, una pratica soluzione che ti permette di **installare la porta scorrevole senza intervenire sulla muratura**, sfruttando un binario esterno muro.

*BinAir is the wall mounted sliding door kit, a practical solution that allows you to **install a sliding door with no need to intervene on the masonry**, using a wall mounted track.*



03

LINEA PORTE

DOORS

Per completare le soluzioni sia classiche che filo muro, Ermetika propone un'ampia gamma di porte interne che possono essere laccate, rivestite o tinteggiate per mimetizzarsi con la parete che le ospita o per creare vivaci contrasti. In questo panorama, si aggiunge la collezione di Porte ECHO: una linea di pannelli in essenza legno sviluppata per offrire un design caratteristico e personalizzabile sotto ogni aspetto.

To complete both the classic and flush door solutions, Ermetika offers a wide range of interior doors that can be lacquered, painted or coated with wallpaper in order to blend them with the wall or to create vivid contrasts. In this panorama, the ECHO door collection stands out: it is a range of laminated door panels developed to offer a peculiar design, that can be customised in every aspect.

PORTA ECHO BATTENTE

La Porta Echo battente è una porta filo muro con rivestimento in "decorativo 3D" (disponibile in 6 diverse finiture), arricchita da un profilo perimetrale in alluminio anodizzato (disponibile in 4 diverse finiture) caratterizzata da un design ricercato e da un'elevata possibilità di personalizzazione.

The Echo Swing Door is a flush-to-wall door with 3D decorative finishes (available in 6 different types), enriched with an anodized aluminum perimeter profile (available in 4 different colours) characterized by a refined design and high customization possibilities.

**PORTA ECHO SCORREVOLE**

La Porta Echo Scorrevole è una porta filo muro con rivestimento in "decorativo 3D" (disponibile in 6 diverse finiture), arricchita da un profilo perimetrale in alluminio anodizzato (disponibile in 4 diverse finiture). La Porta è caratterizzata da un design ricercato e da un'elevata possibilità di personalizzazione.

The Echo Sliding Door is a flush-to-wall panel with 3D decorative finishes (available in 6 different finishes), enhanced by an anodized aluminum perimeter profile (available in 4 different finishes). The door is characterized by a refined design and a high degree of customization.

**PORTA SWING**

La porta Swing è il modello ideale per esigenze di progettazione ispirate al design minimalista, che si integra perfettamente nella parete ospitante grazie al telaio Absolute Swing. Il design essenziale non presenta alcun tipo di finitura esterna, per accostarsi al meglio con l'ambiente; ciò non vieta la possibilità di decorare, rivestire o tingere il pannello porta.

The Swing door is the ideal model for projects inspired by minimalist design. It blends perfectly into the host wall thanks to the Absolute Swing frame. Its essential design does not present any external elements, however it can be decorated or covered with wallpaper for maximum customization and/or camouflage.

**PORTA VELIO AB**

Velio AB è una porta per chi cerca minimalismo ed eleganza. È disponibile in legno grezzo (MDF) da tingere o in legno laccato a tinte RAL. Compatibile con il sistema filo muro scorrevole Absolute Evo, viene fornita completa di serratura e/o maniglia.

Velio AB is a door made for those seeking minimalism and elegance. It is available both as primed door ready to be painted or in lacquered wood with RAL colors. Compatible with Absolute Evo flush pocket door system, it comes complete with lock and/or handle.

**PORTA VELIO**

Velio è la porta compatibile con il modello scorrevole classico Evolution. Le forme semplici, arricchite da stipiti e coprifili, la rendono versatile per ogni stile decorativo. È disponibile in legno grezzo (MDF) da tingere o in legno laccato a tinte RAL; viene fornita completa di serratura e/o maniglia.

Velio is the door compatible with the classic Evolution pocket door system. Its simple shape, enriched by jambs and architraves, makes it suitable for any decoration style. It is available as primed door ready to be painted or in lacquered wood with RAL colors; it comes complete with lock and/or handle.

**PORTA ANISE**

Anise è la porta che completa il controtelaio semi-circolare Arkimede. Disponibile in legno grezzo tanganica o laccata con tinte RAL a scelta; viene fornita completa di stipiti e coprifili piatti telescopici.

Anise is the door that completes the curved pocket door system Arkimede. Available in Tanganyika wood or lacquered with the RAL color of your choice; it comes complete with jambs and flat telescopic doorposts.



Scegli le finiture delle tue **Porte Echo**
Choose your Echo Door finishes



Accessori
Accessories

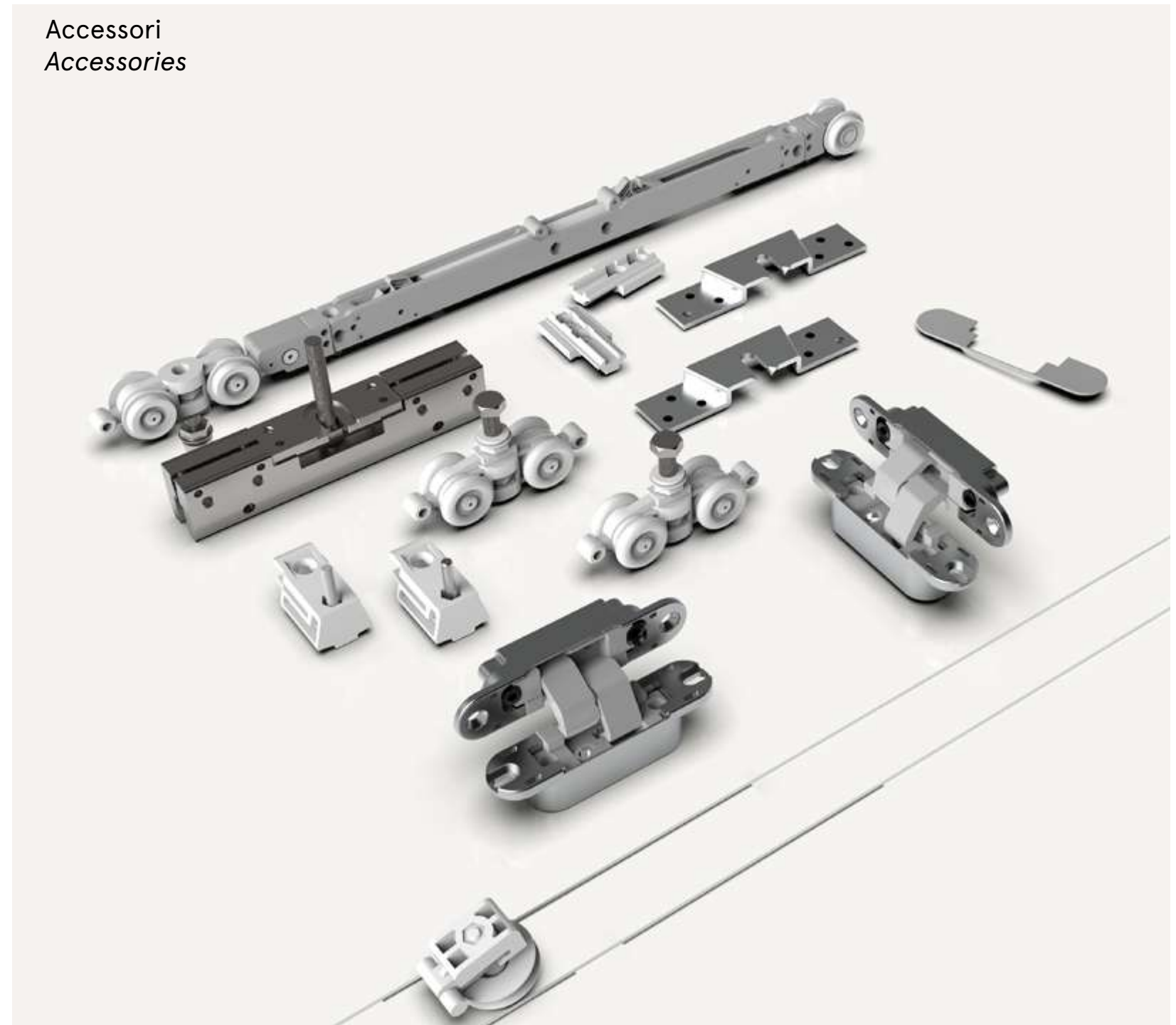

Scannerizza il Qr code
e seguici sulle nostre piattaforme!

*Scan the Qr code and follow us
on our channels!*



Ecco un modo per restare sempre in contatto
ed essere aggiornati sulle ultime novità di **Ermetika**.

*Here's a way to stay in touch and be updated
on the latest **Ermetika** news.*

Ermetika srl Via Trani ,126
76121 Barletta - Italy

ermetika.com

Ermetika[®]
DESIGN PASSAGES

