



ETA-Danmark A/S  
Göteborg Plads 1  
DK-2150 Nordhavn  
Tel. +45 72 24 59 00  
Fax +45 72 24 59 04  
Internet [www.etadanmark.dk](http://www.etadanmark.dk)

Authorised and notified according  
to Article 29 of the Regulation (EU)  
No 305/2011 of the European  
Parliament and of the Council of 9  
March 2011

MEMBER OF EOTA



## European Technical Assessment ETA-19/0815 of 2020/09/01

### I General Part

**Technical Assessment Body issuing the ETA and designated according to Article 29 of the Regulation (EU) No 305/2011:** ETA-Danmark A/S

**Trade name of the construction product:**

CA POLY - EKOR Injection anchor, injection type

**Product family to which the above construction product belongs:**

Bonded anchor with anchor rod for use in non-cracked concrete. Sizes: M8-M10-M12-M16

**Manufacturer:**

TORGGLER S.r.l.  
Via Verande 1/A  
IT-39012 Merano (BZ)  
Tel. +39 0473 282400  
Internet [www.torggler.com](http://www.torggler.com)

**Manufacturing plant:**

TORGGLER S.r.l.  
Manufacturing plant II

**This European Technical Assessment contains:**

19 pages including 14 annexes which form an integral part of the document

**This European Technical Assessment is issued in accordance with Regulation (EU) No 305/2011, on the basis of:**

EAD 330499-00-0601 Bonded fasteners for use in concrete

The ETA with the same number issued on 2019-12-13

Translations of this European Technical Assessment in other languages shall fully correspond to the original issued document and should be identified as such.

Communication of this European Technical Assessment, including transmission by electronic means, shall be in full (except the confidential Annexes referred to above). However, partial reproduction may be made, with the written consent of the issuing Technical Assessment Body. Any partial reproduction has to be identified as such.

## **II SPECIFIC PART OF THE EUROPEAN TECHNICAL ASSESSMENT**

### **1 Technical description of product and intended use**

#### **Technical description of the product**

The CA POLY - EKOR Injection anchor is a bonded anchor (injection type) consisting of an injection mortar cartridge equipped with a special mixing nozzle and threaded anchor rod of the sizes from M8 to M16 made of:

- galvanized carbon steel,
- stainless steel A4-70, A4-80 or high corrosion resistant stainless steel with hexagon nut and washer.

The threaded rod is placed into a drilled hole previously injected (using an applicator gun) with a mortar with a slow and slight twisting motion. The anchor rod is anchored by the bond between rod, mortar and concrete.

The threaded rod is available for all diameters with three types of tip end a one side 45° chamfer, a two-sided 45° chamfer or a flat. The threaded rods are either delivered with the mortar cartridges or commercial standard threaded rods purchased separately. Each mortar cartridge is marked with the identifying mark of the producer and with the trade name. The mortar cartridges are available in different sizes.

The anchor in the range of M8 to M16 and the mortar cartridges corresponds to the drawings given in the Annex A1 to A4.

The characteristic material values, dimensions and tolerances of the anchors not indicated in Annexes shall correspond to the respective values laid down in the technical documentation<sup>1</sup> of this European Technical Assessment.

The anchors are intended to be used with embedment depth given in Annex A2, Table A1. For the installed anchor see Figure given in Annex A1. The intended use specifications of the product are detailed in the Annex B1.

### **2 Specification of the intended use in accordance with the applicable EAD**

The performances given in Section 3 are only valid if the anchor is used in compliance with the specifications and conditions given in Annex B1 to B6.

The provisions made in this European Technical Assessment are based on an assumed intended working life of the anchor of 50 years.

The indications given on the working life cannot be interpreted as a guarantee given by the producer or Assessment Body, but are to be regarded only as a means for choosing the right products in relation to the expected economically reasonable working life of the works.

---

<sup>1</sup> The technical documentation of this European Technical Assessment is deposited at ETA-Danmark and, as far as relevant for the tasks of the Notified bodies involved in the attestation of conformity procedure, is handed over to the notified bodies.

### **3 Performance of the product and references to the methods used for its assessment**

#### **3.1 Characteristics of product**

##### **Mechanical resistance and stability (BWR 1):**

The essential characteristics are detailed in the Annex from C1 to C2.

##### **Safety in case of fire (BWR 2):**

The essential characteristics are detailed in the Annex C3.

##### **Hygiene, health and the environment (BWR3):**

No performance assessed

##### **Safety in use (BWR4):**

For basic requirement Safety in use the same criteria are valid for Basic Requirement Mechanical resistance and stability (BR1).

##### **Sustainable use of natural resources (BWR7)**

No performance assessed

Other Basic Requirements are not relevant.

#### **3.2 Methods of assessment**

The assessment of fitness of the anchor for the intended use in relation to the requirements for mechanical resistance and stability and safety in use in the sense of the Basic Requirements 1 and 4 has been made in accordance with the EAD 330499-00-0601 Bonded fasteners for use in concrete.

## **4 Attestation and verification of constancy of performance (AVCP)**

### **4.1 AVCP system**

According to the decision 96/582/EC of the European Commission, the system(s) of assessment and verification of constancy of performance (see Annex V to Regulation (EU) No 305/2011) is 1.

## **5 Technical details necessary for the implementation of the AVCP system, as foreseen in the applicable EAD**

Technical details necessary for the implementation of the AVCP system are laid down in the control plan deposited at ETA-Danmark prior to CE marking.

Issued in Copenhagen on 2020-09-01 by



Thomas Bruun  
Managing Director, ETA-Danmark A/S

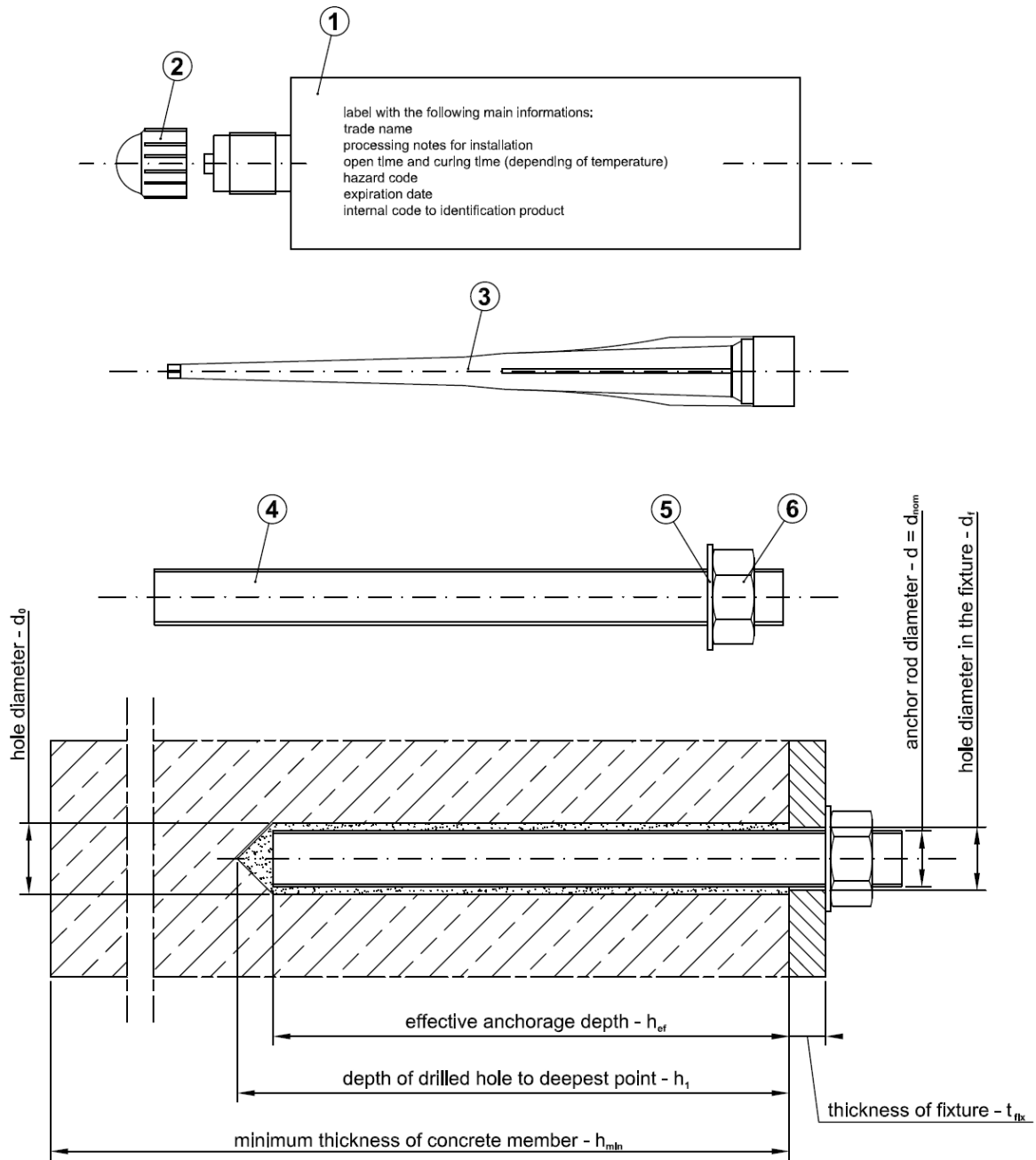

- ① Cartridge
- ② Sealing cap
- ③ Mixer
- ④ Anchor threaded rod
- ⑤ Washer
- ⑥ Hexagon nut

**CA POLY - EKOR Injection anchor**

Product and intended use

**Annex A1**  
 of European  
 Technical Assessment  
 ETA-19/0815

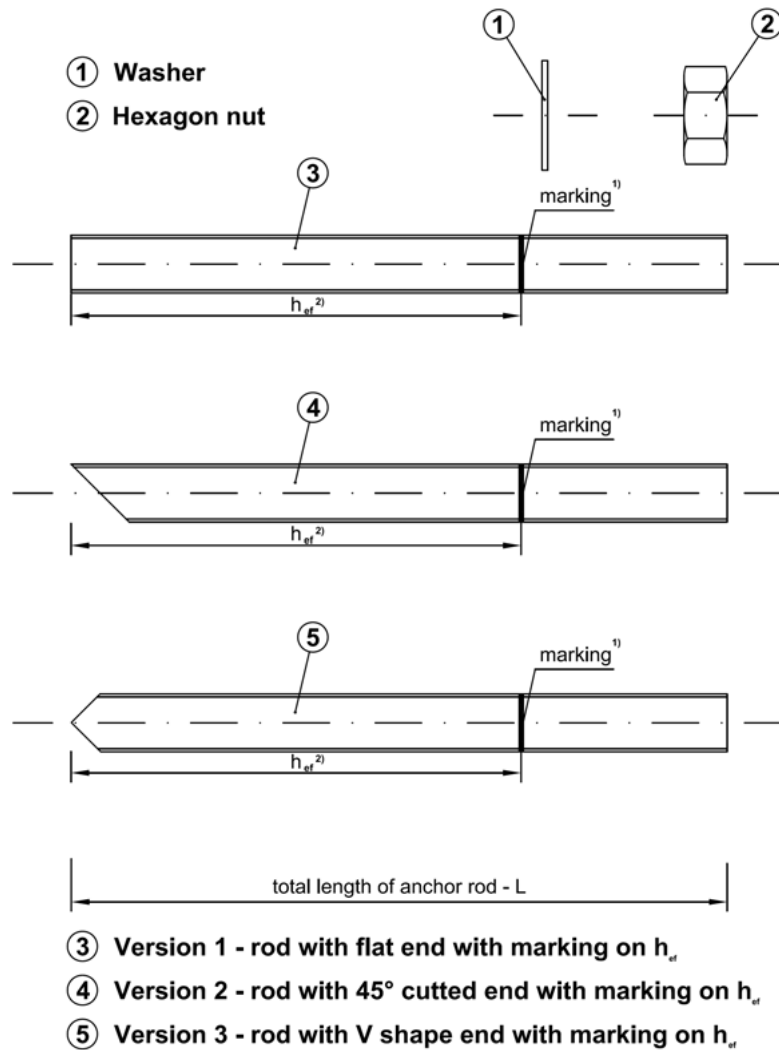

**Table A1: Threaded rod dimensions**

Size	d [mm]	$h_{ef,min}$ [mm]	$h_{ef,max}$ [mm]
M8	8	60	160
M10	10	70	200
M12	12	80	240
M16	16	100	320

<sup>1)</sup> Marking according to clause 1.1. of EAD 330499-00-0601

<sup>2)</sup> Effective anchorage depths according to the range specified in Table A1.

**CA POLY - EKOR Injection anchor**

Threaded rod types and dimensions

**Annex A2**  
of European  
Technical Assessment  
ETA-19/0815

**Table A2: Threaded rod materials**

Part	Designation		
	Steel: zinc plated $\geq 5 \mu\text{m}$ acc. to EN ISO 4042 hot dipped galvanized $\geq 45 \mu\text{m}$ EN ISO 10684	Stainless steel A4	High corrosion resistance stainless steel (HCR)
Threaded rod	Steel property class from 4.8 to 8.8, acc. to EN ISO 898-1	Material 1.4401; 1.4404; 1.4578; 1.4571; 1.4439; 1.4362; 1.4062 acc. to EN 10088-1; property class 50, 70 or 80 acc. to EN ISO 3506-1	Material 1.4529 / 1.4565, acc. to EN 10088-1; property class 50, 70 or 80 acc. to EN ISO 3506-1
Washer EN ISO 7089	Steel acc. to corresponding to threaded rod material	Material 1.4401; 1.4404; 1.4578; 1.4571; 1.4439; 1.4362; 1.4062 acc. to EN 10088-1; corresponding to threaded rod material	Material 1.4529 / 1.4565, acc. to EN 10088-1; corresponding to threaded rod material
Hexagon nut	Steel, property class from 4 to 8 acc. to EN 898-2; corresponding to threaded rod material	Material 1.4401; 1.4404; 1.4578; 1.4571; 1.4439; 1.4362; 1.4062 acc. to EN 10088-1; property class 50, 70 or 80 acc. to EN ISO 3506-1	Material 1.4529 / 1.4565, acc. to EN 10088-1; property class 50, 70 or 80 acc. to EN ISO 3506-1

Commercial standard threaded rods with:

- material and mechanical properties according to Table A2,
- confirmation of material and mechanical properties by inspection certificate 3.1 according to EN-10204:2004,
- marking of the threaded rod with the embedment depth.

**Table A3: Injection mortar**

Product	Composition
<b>CA POLY - EKOR Injection anchor two components injection mortar<sup>1)</sup></b>	Mortar resin styrene-free, hardener, filler

**CA POLY - EKOR Injection anchor**

Materials

**Annex A3**  
of European  
Technical Assessment  
ETA-19/0815



### coaxial cartridge - sizes from 75 ml to 420 ml

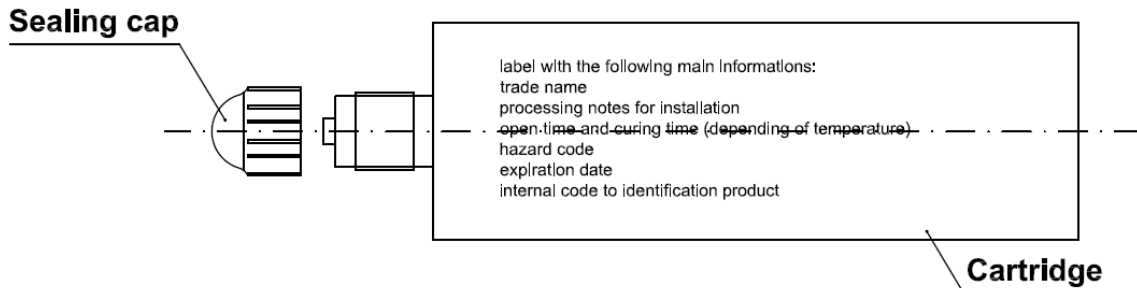

### CIC foil cartridge - sizes from 165 ml to 300 ml

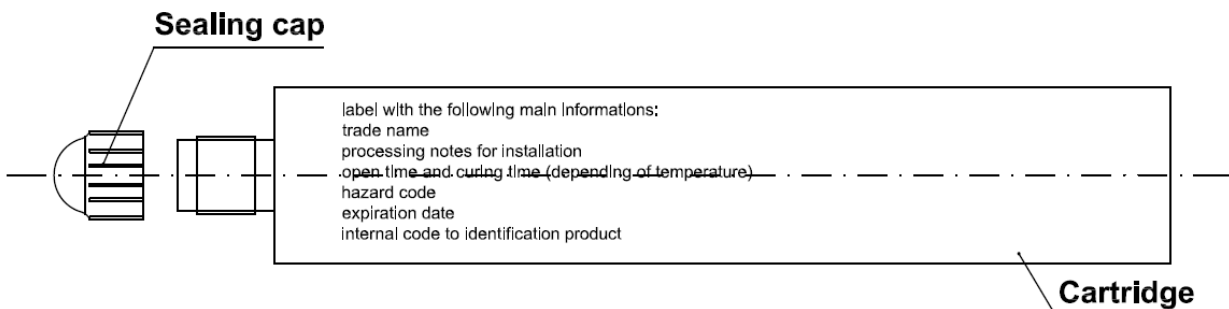

### coaxial peeler cartridge - size of 280 ml

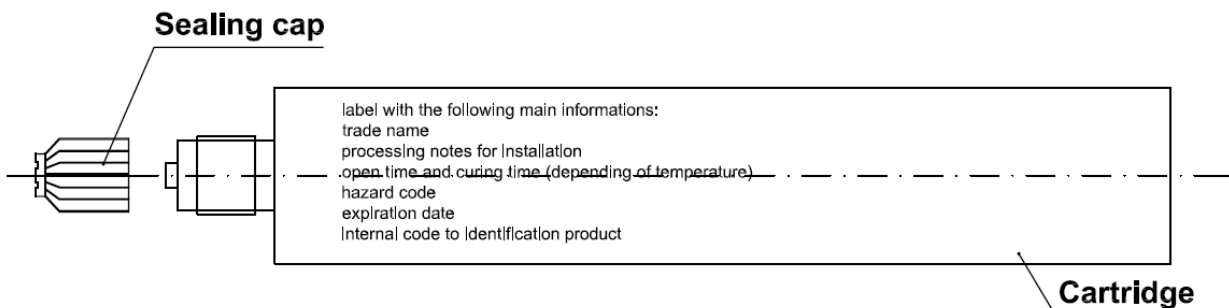

### MIXER - the mixer is suitable for each type of cartridge

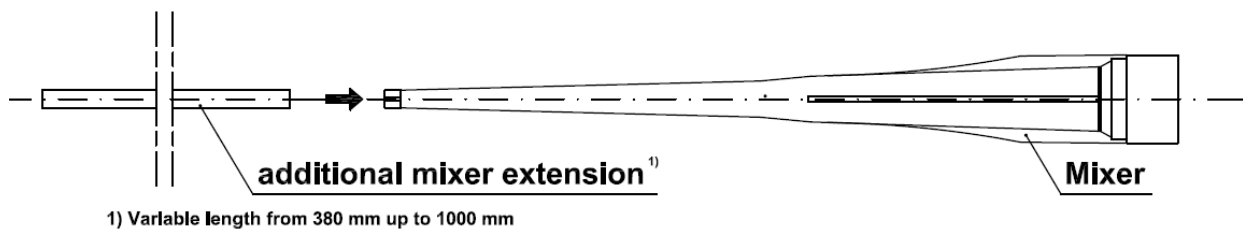

CA POLY - EKOR Injection anchor

Cartridge types and sizes

Annex A4  
 of European  
 Technical Assessment  
 ETA-19/0815

**Use:**

The anchors are intended to be used for anchorages for which requirements for mechanical resistance and stability and safety in use in the sense of the Basic Requirements 1 and 4 of Regulation 305/2011 (EU) shall be fulfilled and failure of anchorages made with these products would compromise the stability of the works, cause risk to human life and/or lead to considerable economic consequences.

**Anchors subject to:**

- Static and quasi-static loads: sizes from M8 to M16.

**Base materials:**

- Reinforced or unreinforced normal weight concrete of strength class C20/25 at minimum to C50/60 at maximum according to EN 206-1.
- Non cracked concrete.

**Temperature range:**

The anchors may be used in the following temperature range:

- a) -40°C to +50°C (max. short term temperature +50°C and max. long term temperature +40°C).

**Use conditions (Environmental conditions):**

- Elements made of galvanized steel may be used in structures subject to dry internal conditions only.
- Elements made of stainless steel may be used in structures subject to dry internal conditions and also in concrete subject to external atmospheric exposure (including industrial and marine environment) or exposure in permanently damp internal conditions if no particular aggressive conditions exist. Such particular aggressive conditions are e.g. permanent, alternating immersion in seawater or the splash zone of seawater, chloride atmosphere of indoor swimming pools or atmosphere with extreme chemical pollution (e.g. in desulphurization plants or road tunnels where de-icing materials are used).
- Elements made of high corrosion resistant steel may be used in structures subject to dry internal conditions and also in concrete subject to external atmospheric exposure or exposure in permanently damp internal conditions or in other particular aggressive conditions. Such particular aggressive conditions are e.g. permanent, alternating immersion in seawater or the splash zone of seawater, chloride atmosphere of indoor swimming pools or atmosphere with chemical pollution (e.g. in desulphurization plants or road tunnels where de-icing materials are used).

**Installation:**

The anchors may be installed in:

- Dry or wet concrete (use category I1): sizes from M8 to M16.
- Installation direction D3 (downward and horizontal and upwards installation): sizes from M8 to M16.
- The anchor is suitable for hammer drilled holes: sizes from M8 to M16.

**Proposed design methods:**

- Static and quasi-static load: EN 1992-4

<p>CA POLY - EKOR Injection anchor</p>	<p>Annex B1 of European Technical Assessment ETA-19/0815</p>
<p>Intended use - Specification</p>	

**Table B1: Installation data**

Size		M8	M10	M12	M16
Nominal drilling diameter	$d_0$ [mm]	10	12	14	18
Maximum diameter hole in the fixture	$d_{fix}$ [mm]	9	12	14	18
Embedment depth	$h_{ef,min}$ [mm]	60	70	80	100
	$h_{ef,max}$ [mm]	160	200	240	320
Depth of the drilling hole	$h_1$ [mm]	$h_{ef} + 5$ mm			
Minimum thickness of the slab	$h_{min}$ [mm]	$h_{ef} + 30$ mm; $\geq 100$ mm			$h_{ef} + 2d_0$
Torque moment	$T_{inst}$ [Nm]	10	20	40	80
Thickness to be fixed	$t_{fix,min}$ [mm]	$> 0$			
	$t_{fix,max}$ [mm]	$< 1500$			
Minimum spacing	$S_{min}$ [mm]	40	50	60	75
Minimum edge distance	$C_{min}$ [mm]	40	50	60	75

**Table B2: Minimum curing time <sup>1)</sup>**

Concrete temperature	Processing time	Minimum curing time <sup>3)</sup>
0°C <sup>2)</sup>	25 min	180 min
5°C <sup>2)</sup>	15 min	120 min
10°C	12 min	90 min
15°C	8 min	60 min
20°C	6 min	45 min
25°C	4 min	30 min
30°C	3 min	20 min

1) the minimum time from the end of the mixing to the time when the anchor may be torque or loaded (whichever is longer).

2) minimum resin temperature recommended, for injection between 5°C and 0°C, equal to 10°C.

3) minimum curing time for dry and wet conditions.

**CA POLY - EKOR Injection anchor**

Intended use – Installation data

**Annex B2**  
of European  
Technical Assessment  
ETA-19/0815

**Manual blower pump: nominal dimensions**

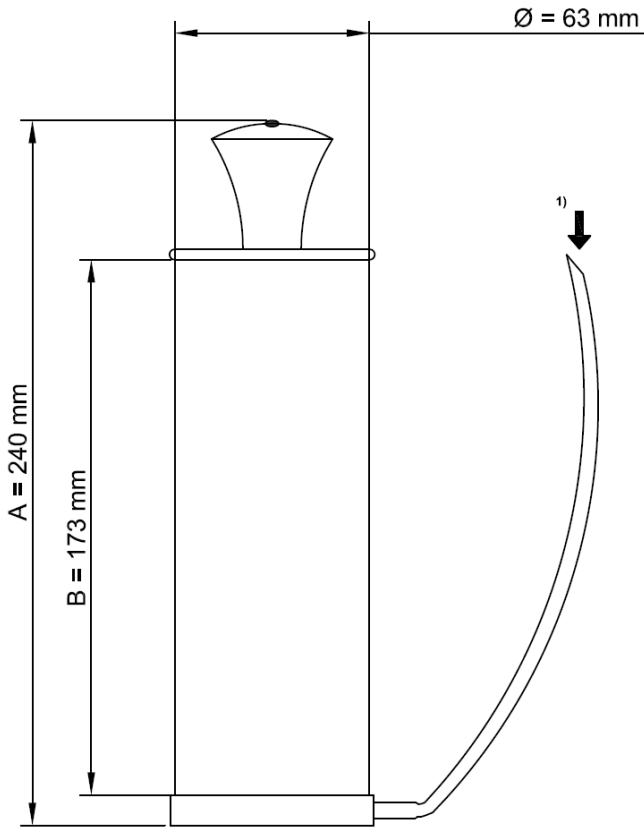

**It is possible to use the mixer extension with the manual blower pump.**

**However it is possible to blow the hole using the mechanical air system (compressed air) also with the mixer extension**



**Suitable min pressure 6 bar at 6 m<sup>3</sup>/h  
Oil-free compressed air  
Recommended air gun with an orifice opening of minimum 3.5 mm in diameter**

1) Position to Insert the mixer extension



**Mixer extension (from 380 mm to 1000 mm) with nominal diameter equal to 8 mm**

<b>CA POLY - EKOR Injection anchor</b>	<b>Annex B3</b> of European Technical Assessment ETA-19/0815
Cleaning tools (1)	

### Standard brush

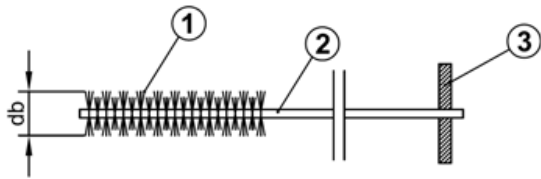

- ① Steel bristles
- ② Steel stem
- ③ Wood handle

**Table B3: Standard brush diameter**

Threaded rod diameter - d			M8	M10	M12	M16
<b>d<sub>0</sub></b>	Nominal drill hole	[mm]	10	12	14	18
<b>d<sub>b</sub></b>	Brush diameter	[mm]	12	14	16	20

### Special brush

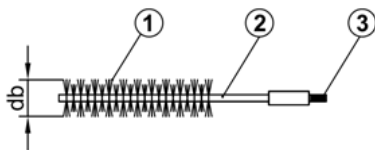

- ① Steel bristles
- ② Steel stem
- ③ Threaded connection for drilling tool extension
- ④ Extension special brush
- ⑤ Drilling tool connection (SDS connection)



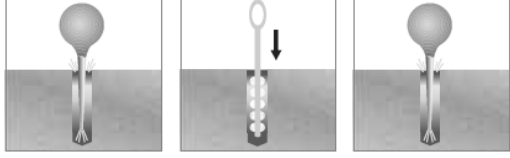

**Table B4: Special brush diameter (mechanical brush)**

Threaded rod diameter - d			M8	M10	M12	M16
<b>d<sub>0</sub></b>	Nominal drill hole	[mm]	10	12	14	18
<b>d<sub>b</sub></b>	Brush diameter	[mm]	12	14	16	20

**CA POLY - EKOR Injection anchor**

Cleaning tools (2)

**Annex B4**  
of European  
Technical Assessment  
ETA-19/0815

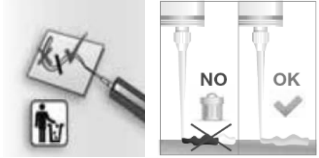
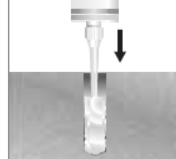
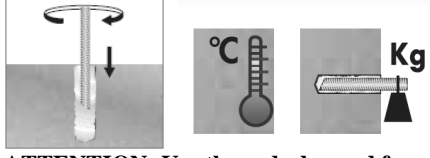
1		<p>Drill the hole with the correct diameter and depth using a rotary percussive machine. Check the perpendicularity of the hole during the drilling operation.</p>
2	 <p><b>4 x Blower      4 x Brush      4 x Blower</b></p> <p><b>if necessary use a mixer extension for the blower operation (see Annex B3). In case of use of compressed air each blower operation must be done for 5 second. Use compressed air free oil.</b></p>	<p>Clean the hole from drilling dust: the hole shall be cleaned by at least 4 blowing operations, by at least 4 brushing operations followed again by at least 4 blowing operations; before brushing clean the brush and check (see Annex B4) if the brush diameter is sufficient. For the blower tools see Annex B3.</p>
3		<p>For coaxial and peeler cartridges unscrew the front cup, screw on the mixer and insert the cartridge in the gun. For the size 300 ml and 165 ml, unscrew the front cup, pull-out the steel closing clip according to the following operations: - insert the mixer in the eye of the plastic extractor, - pull the extractor to unhook the steel closing clip of the foil. In the version without extractor cut the foil pack. After that, screw on the mixer and insert the cartridge in the gun.</p>
4		<p>Before starting to use the cartridge, eject a first part of the product, being sure that the two components are completely mixed. The complete mixing is reached only after that the product, obtained by mixing the two components, comes out from the mixer with a uniform color.</p>
5	 <p><b>if necessary use a mixer extension for the injection (see Annex A4)</b></p>	<p>Fill the drilled hole uniformly starting from the drilled hole bottom, to avoid entrapment of the air; remove the mixer slowly bit by bit during pressing-out; filling the drill hole with a quantity of the injection mortar corresponding to 2/3 of the drill hole depth.</p>
6	 <p><b>ATTENTION: Use the rods dry and free oil and other contaminants</b></p>	<p>Insert immediately the rod, marked according to the proper anchorage depth, slowly and with a slight twisting motion, removing excess of injection mortar around the rod. Observe the processing time according Annex B2. Wait the curing time according Annex B2.</p>
<p><b>CA POLY - EKOR Injection anchor</b></p>		<p><b>Annex B5</b> of European Technical Assessment ETA-19/0815</p>
<p>Procedure of installation</p>		

For overhead installation follow the standard procedure detailed in Annex B5 up to point 4.  
Put the mixer extension (cut the proper length) on the mixer and follow the below procedure:

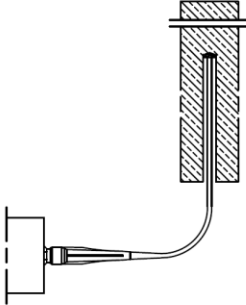
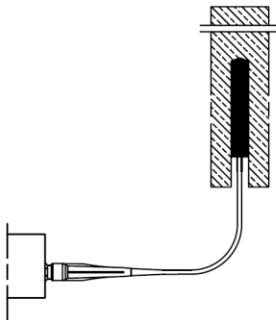
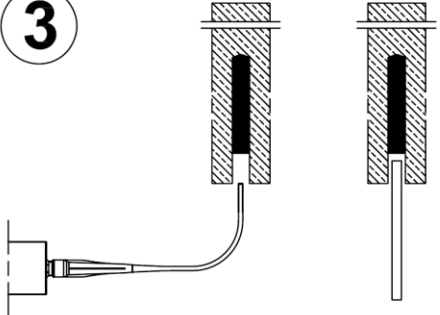
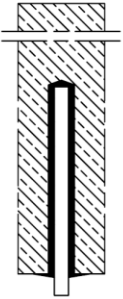
<p><b>1</b></p> 	<p><b>1 - Start injection</b></p> <p>Inject from the bottom of the hole. Use battery or pneumatic dispenser if the anchorage depth is greater than 200 mm.</p>
<p><b>2</b></p> 	<p><b>2 - Injection phase</b></p> <p>Inject the product about 2/3 of the hole depth. Remove the mixer extension slowly bit by bit during pressing-out.</p>
<p><b>3</b></p> 	<p><b>3 - End injection</b></p> <p>Remove the mixer extension. Insert immediately the rod (turn the rod during the insertion).</p>
<p><b>4</b></p> 	<p><b>4 - End installation</b></p> <p>To avoid the slipping of the rod during the open time of the product (due to the rod own weight) use a temporary interlocking element (for ex. wedge of wood)</p>

Observe the open time and wait the curing time according to Annex B2.

CA POLY - EKOR Injection anchor

Overhead application

Annex B6

of European  
Technical Assessment  
ETA-19/0815

**Table C1: Characteristic values for tension and shear load in non- cracked concrete.**

ESSENTIAL CHARACTERISTICS		PERFORMANCE			
<b>Installation parameters</b>		<b>M8</b>	<b>M10</b>	<b>M12</b>	<b>M16</b>
d [mm]		8	10	12	16
d <sub>0</sub> [mm]		10	12	14	18
d <sub>fix</sub> [mm]		9	12	14	18
h <sub>1</sub> [mm]		h <sub>ef</sub> + 5 mm			
h <sub>min</sub> [mm]		h <sub>ef</sub> + 30 mm; ≥ 100 mm			h <sub>ef</sub> + 2d <sub>0</sub>
T <sub>inst</sub> [Nm]		10	20	40	80
t <sub>fix</sub> [mm]	Min	> 0			
	Max	≤ 1500 mm			
S <sub>min</sub> [mm]		40	40	40	50
C <sub>min</sub> [mm]		40	40	40	50
γ <sub>2</sub> = γ <sub>inst</sub> [-]	Category 1 – for tensile and shear load	1,00			
<b>Characteristic resistance for tension load</b>		<b>M8</b>	<b>M10</b>	<b>M12</b>	<b>M16</b>
<b>Steel failure</b> <sup>1)</sup>					
N <sub>Rk,s</sub> [kN]		Characteristic resistance according to the design method specified in Annex B1			
<b>Concrete cone failure</b>					
N <sub>Rk,c</sub> [kN]		Characteristic resistance according to the design method specified in Annex B1			
S <sub>cr,N</sub> [mm]		3h <sub>ef</sub>			
C <sub>cr,N</sub> [mm]		1.5h <sub>ef</sub>			
k <sub>urc,N</sub> [-]		Characteristic resistance according to the design method specified in Annex B1			
<b>Combined pullout and concrete cone failure</b>					
τ <sub>Rk,ucr</sub> [N/mm <sup>2</sup> ] concrete C20/25 Temperature range -40°C/+50°C (T <sub>mlp</sub> = +40°C)		<b>12</b>	<b>12</b>	<b>11</b>	<b>9</b>
ψ <sub>c,ucr</sub> C30/37 [-]		1,04			
ψ <sub>c,ucr</sub> C40/50 [-]		1,07			
ψ <sub>c,ucr</sub> C50/60 [-]		1,09			
<b>Splitting failure</b>					
S <sub>cr,sp</sub> [mm]	for h = h <sub>min</sub>	S <sub>cr,sp</sub> = 4 h <sub>ef</sub>			
	if h <sub>min</sub> ≤ h < 2 h <sub>ef</sub>	S <sub>cr,sp</sub> = interpolated value			
	if h ≥ 2 h <sub>ef</sub>	S <sub>cr,sp</sub> = S <sub>cr,Np</sub> = 20 d (τ <sub>Rk,ucr</sub> /7,5) <sup>0,5</sup> ≤ 3 h <sub>ef</sub>			
C <sub>cr,sp</sub> [mm]		0,5 S <sub>cr,sp</sub>			
<b>Resistance for shear load</b>		<b>M8</b>	<b>M10</b>	<b>M12</b>	<b>M16</b>
<b>Steel failure without lever arm</b> <sup>1)</sup>					
V <sub>Rk,s</sub> [kN]		Characteristic resistance according to the design method specified in Annex B1			
k <sub>7</sub> [-]		1			
<b>Steel failure with lever arm</b> <sup>1)</sup>					
M <sup>0</sup> <sub>Rk,s</sub> [kN]		Characteristic resistance according to the design method specified in Annex B1			
<b>Concrete pry-out failure</b>					
k = k <sub>3</sub> = k <sub>8</sub> [-]		2			
<b>Concrete edge failure</b>					
V <sub>Rk,c</sub> [kN]		Characteristic resistance according to the design method specified in Annex B1			
d <sub>nom</sub> [mm]		8	10	12	16
l <sub>f</sub> [mm]		h <sub>ef</sub>			

<sup>1)</sup>Note: Steel property class according to Annex A3 Table A2.

<b>CA POLY - EKOR Injection anchor</b>	<b>Annex C1</b> of European Technical Assessment ETA-19/0815
Performance for static and quasi-static loads: Resistances	



**Table C2: Displacements under service loads (static and quasi static) in non- cracked concrete.**

ESSENTIAL CHARACTERISTICS	PERFORMANCE			
<b>Displacement under service load Tensile load</b>	<b>M8</b>	<b>M10</b>	<b>M12</b>	<b>M16</b>
$F_{unc}$ [kN] for concrete from C20/25 to C50/60	9,5	13,8	16,9	23,6
$\delta_{N0,unc}$ [mm]	0,30	0,30	0,35	0,35
$\delta_{N\infty,unc}$ [mm]	0,73			
<b>Displacement under service load Shear load</b>	<b>M8</b>	<b>M10</b>	<b>M12</b>	<b>M16</b>
$F_{unc}$ [kN] for concrete from C20/25 to C50/60	10,5	16,6	24,1	44,8
$\delta_{V0,unc}$ [mm]	2,00	2,00	2,00	2,00
$\delta_{V\infty,unc}$ [mm]	3,00			

**Note: Design method according to Annex B1.**

**CA POLY - EKOR Injection anchor**

Performance for static and quasi-static loads: Displacements

**Annex C2**  
of European  
Technical Assessment  
ETA-19/0815

**Table C3: Resistance to fire**

ESSENTIAL CHARACTERISTICS	PERFORMANCE
Resistance to fire	NPA

**Table C4: Reaction to fire**

ESSENTIAL CHARACTERISTICS	PERFORMANCE
Reaction to fire	In the final application the thickness of the mortar layer is about 1 to 2 mm and most of the mortar is material classified class A1 according to EC Decision 96/603/EC. Therefore, it may be assumed that the bonding material (synthetic mortar or a mixture of synthetic mortar and cementitious mortar) about the metal anchor in the end use application do not make any contribution to fire growth or to the fully developed fire and they have no influence on the smoke hazard.

**CA POLY - EKOR Injection anchor**

Performance for exposure to fire

**Annex C3**  
of European  
Technical Assessment  
ETA-19/0815

**Table C5: Terminology and symbols**

<b>TERMINOLOGY AND SYMBOLS</b>	
d	Diameter of anchor bolt or thread diameter
d <sub>0</sub>	Drill hole diameter
d <sub>fix</sub>	Diameter of clearance hole in the fixture
h <sub>ef</sub>	Effective anchorage depth
h <sub>l</sub>	Depth of the drilling hole
h <sub>min</sub>	Minimum thickness of concrete member
T <sub>inst</sub>	Torque moment to installation
t <sub>fix</sub>	Thickness to be fixed
S <sub>min</sub>	Minimum allowable spacing
C <sub>min</sub>	Minimum allowable edge distance
k <sub>surc,N</sub> [-]	Factor for concrete cone in uncracked concrete
S <sub>cr,N</sub>	Characteristic spacing between two different anchors for the concrete cone failure
C <sub>cr,N</sub>	Characteristic edge distance between two different anchors for the concrete cone failure
S <sub>cr,sp</sub>	Spacing for ensuring the transmission of the characteristic tensile resistance of a single anchor without spacing and edge effects in case of splitting failure
C <sub>cr,sp</sub>	Edge distance for ensuring the transmission of the characteristic tensile resistance of a single anchor without spacing and edge effects in case of splitting failure
N <sub>Rk,s</sub>	Characteristic tension resistance for steel failure
N <sub>Rk,c</sub>	Characteristic tension resistance for concrete cone failure
V <sub>Rk,s</sub>	Characteristic shear resistance for steel failure without lever arm
k <sub>7</sub>	Ductility factor for steel failure in shear load
M <sup>0</sup> <sub>Rk,s</sub>	Characteristic shear resistance for steel failure with lever arm
V <sub>Rk,c</sub>	Characteristic shear resistance for concrete edge failure
d <sub>nom</sub> [mm]	Outside diameter of fastener
l <sub>f</sub> [mm]	Parameter for evaluation of concrete edge failure
τ <sub>Rk,ucr</sub>	Characteristic bond resistance in un-cracked concrete class C20/25
γ <sub>2</sub> = γ <sub>inst</sub>	Partial safety factors for installation
ψ <sub>c,ucr</sub>	Increasing factor for un-cracked concrete
k = k <sub>3</sub> = k <sub>8</sub> [-]	Factor for concrete pry-out failure
F	Service load in un-cracked (ucr) or cracked concrete (cr) in tensile or shear load
δ <sub>0</sub>	Short term displacement under service load in un-cracked (ucr) or cracked concrete (cr) for tensile (N) or shear load (V)
δ <sub>∞</sub>	Long term displacement under service load in un-cracked (ucr) or cracked concrete (cr) for tensile (N) or shear load (V)
NPA	No declared performance

**CA POLY - EKOR Injection anchor**

Terminology and symbols

**Annex C4**  
of European  
Technical Assessment  
ETA-19/0815